

JAGUAR XJ



THE ART OF PERFORMANCE





BY APPOINTMENT TO
HM THE QUEEN
MANUFACTURERS OF
MOTOR VEHICLES
JAGUAR LAND ROVER LIMITED
COVENTRY



BY APPOINTMENT TO
HRH THE DUKE OF EDINBURGH
MANUFACTURERS OF
MOTOR VEHICLES
JAGUAR LAND ROVER LIMITED
COVENTRY



BY APPOINTMENT TO
HRH THE PRINCE OF WALES
MANUFACTURERS OF
MOTOR VEHICLES
JAGUAR LAND ROVER LIMITED
COVENTRY



JAGUAR

THE ART OF PERFORMANCE

Every day we push performance to its limit. Our performance. Our cars' performance.
We innovate, we engineer, we design. We master rules and then break them.
Only to push further. Past the limits of convention. This is when performance becomes art.

Jaguar. The Art of Performance.



CONTENTS

INTRODUCTION

The Concept of XJ	06
XJ - The Facts	08

DESIGN

Exterior Principles	10
Exterior - A Powerful Look	13
Exterior View	15
Interior Technology	17
Interior Luxury	18
Interior Comfort	21
Interior Space	23

PERFORMANCE

Engines	24
All-Aluminium Body	26
Advanced Driving Dynamics	28
XJR - Performance and Luxury	33
XJR - Sporting Style	34

DRIVING TECHNOLOGY

All Surface Progress Control	36
Advanced Drivetrain Technology	38

INFOTAINMENT

InControl Technologies	40
InControl Touch Pro and InControl Connect Pro Audio	43 44

SAFETY AND EFFICIENCY

Advanced Driver Assistance	46
Efficient Technologies	48

PERSONALISATION

XJ - Your Choice	50
Choose your Engine	52
Choose your Model	54
Choose your Colour	56
Choose your Wheels	58
Choose your Interior	60
Choose your Jaguar Accessories	76
Technical Specifications	78
Dimensions	80

JAGUAR WORLD

Jaguar Experience	82
World of Jaguar	84
Glossary and Legal Information	86



Scan to find out more about the Jaguar XJ.

VEHICLE SHOWN: XJ R-SPORT STANDARD WHEELBASE IN ULTIMATE BLACK WITH OPTIONAL FEATURES FITTED (MARKET DEPENDENT)
VEHICLES SHOWN ARE FROM THE JAGUAR GLOBAL RANGE. SPECIFICATIONS, OPTIONS AND AVAILABILITY WILL VARY BETWEEN MARKETS
AND SHOULD BE VERIFIED WITH YOUR LOCAL JAGUAR RETAILER

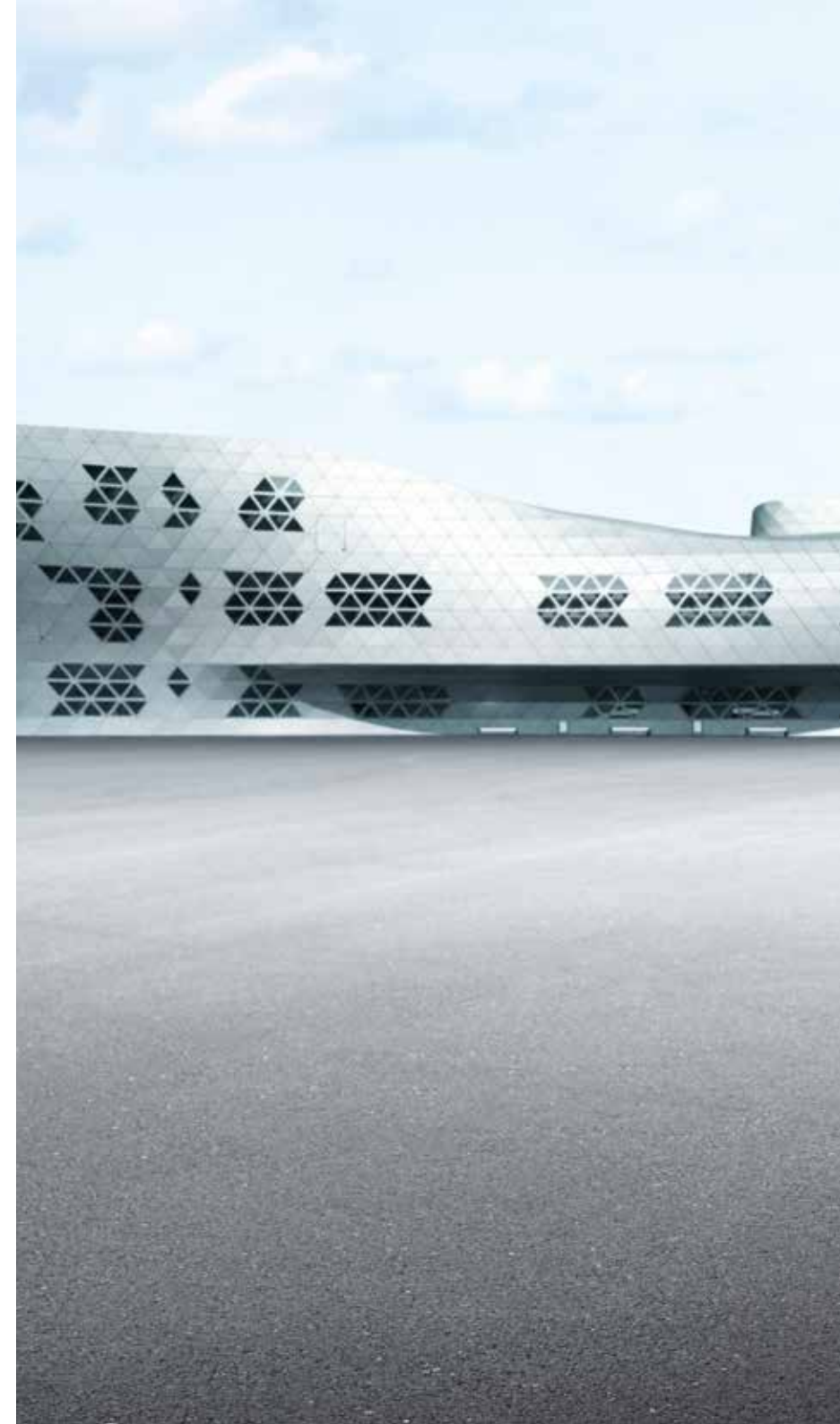

INTRODUCTION THE CONCEPT OF XJ

XJ is Jaguar's pinnacle saloon car, the perfect combination of cutting-edge technology, sporting vehicle dynamics, and opulent luxury. Its assertive styling turns heads with an upright grille and energy efficient full-LED headlights that give prominence to the unique, 'Double J' Daytime Running Light design. While state-of-the-art systems keep you informed and safe, XJ's beauty and craftsmanship are brought together with the power and driving experience you expect from a Jaguar. In the cabin, there's space to stretch out, relax or work with the latest connected technology, InControl Connect Pro. XJ has everything to make your journey more productive, entertaining and relaxed.

Standard and optional features may differ depending on market availability.
Please consult your local Jaguar retailer for details.

VEHICLE SHOWN: XJ AUTOBIOGRAPHY LONG WHEELBASE IN DARK SAPPHIRE WITH OPTIONAL FEATURES FITTED
(MARKET DEPENDENT)



XJ - THE FACTS

Jaguar's technology is focused on enhancing the journey for you and your passengers. Dynamic systems assist performance, handling and comfort. XJ also features the latest connected technology, powerful engines and an array of luxury interior choices.

CONNECTED CAR

InControl Connect Pro is a package of applications and technologies that keeps XJ connected to the world. It runs a suite of useful smartphone apps from the Touch-screen. A powerful antenna provides 3G Internet that can be accessed through an in-car Wi-Fi hotspot. With InControl Remote Premium you can connect to, and monitor, your XJ from anywhere and even pre-heat or cool the cabin before entering.

PERFORMANCE AND EFFICIENCY

The XJ range offers a choice of performance engines, delivering everything from strong fuel economy to a top speed of 280km/h. There is a powerful, refined 3.0 litre 300PS diesel engine offering fuel efficiency of up to 5.7 l/100km and CO₂ emissions of just 149g/km. It delivers 0-100km/h in 6.2 seconds thanks to a torque output of 700Nm. Dynamic 4-cylinder, V6 and V8 petrol engines are also available to suit your driving needs. To smooth your progress, all models feature a sophisticated 8-speed automatic transmission.

ALL-ALUMINIUM CONSTRUCTION

XJ's all-aluminium body architecture is not only strong and rigid but also extremely light making the car highly responsive and agile, as well as fuel efficient. Riveted, and without a single welded joint, the 100 percent aluminium monocoque body structure makes this one of the lightest cars in its class and, without any compromise to the integrity of its body, one of the safest.

Standard and optional features may differ depending on market availability. Please consult your local Jaguar retailer for details.

VEHICLE SHOWN: XJR STANDARD WHEELBASE IN GLACIER WHITE WITH OPTIONAL FEATURES FITTED (MARKET DEPENDENT)

INCONTROL TOUCH PRO

Music, video, navigation, and all the essential in-car controls, including Bluetooth® phone connectivity, are at your fingertips. XJ's Touch-screen responds to smartphone style tap and swipe gestures and uses a powerful Intel Quad Core Processor® to deliver the latest graphics and fast response times.

COLOURS AND MATERIALS

XJ provides true luxury choice throughout. A wealth of colours and wheels are at your disposal including the latest options of Caesium Blue, Cosmic Black and Gallium Silver exterior paints and a stylish 19" Sunda alloy wheel. Choose a Portfolio or Autobiography model and you will discover beautiful Soft grain leather seats defined in a diamond quilted contrast stitched pattern. Exclusive colour co-ordination continues throughout the cabin.



'DOUBLE J' HEADLIGHTS

Jaguar's unique 'Double J' Daytime Running Lights give XJ a distinctive appearance. The full LED headlights supply a 'whiter' light than conventional Xenon beams. Being closer to daylight, objects can be better recognised, helping increase comfort and safety during night driving.



DESIGN EXTERIOR PRINCIPLES



DESIGN PURITY

POWERFUL STANCE

XJ stands out: authoritative, elegant, and powerful. XJ's teardrop shape is formed for optimum aerodynamic efficiency, reducing air resistance to a minimum, improving acceleration, fuel efficiency and CO₂ emissions. The shape is the result of exhaustive computational modelling where aesthetics and aerodynamics work together. The chrome outlined side windows emphasise XJ's pure, elongated form. XJ's low, wide stance and long, taut waistline create a commanding presence, while inside the cabin still feels airy and spacious thanks to its panoramic roof and smart design.

VEHICLE SHOWN: XJ AUTOBIOGRAPHY LONG WHEELBASE IN DARK SAPPHIRE
WITH OPTIONAL FEATURES FITTED (MARKET DEPENDENT)







EXTERIOR - A POWERFUL LOOK



BOLD FRONT GRILLE

'DOUBLE J' HEADLIGHTS

XJ's assertive front styling includes an upright front grille design with mesh detail. The grille is framed by energy efficient full-LED headlights, sporting Jaguar's unique 'Double J' Daytime Running Light design. Producing a light with a colour temperature closer to natural daylight, objects can be better recognised helping increase comfort and safety during night driving.

At the rear, finishing touches include elliptical tailpipes and LED tail lights incorporating a distinctive pinstripe graphic that provides a crisp and clear 'ribbon of light'. The LED tail lights are brighter, more efficient and illuminate faster than halogen bulbs contributing to XJ's overall drive for greater efficiency.

Standard and optional features may differ depending on market availability.
Please consult your local Jaguar retailer for details.

**VEHICLE SHOWN: XJ R-SPORT STANDARD WHEELBASE IN ULTIMATE BLACK WITH OPTIONAL FEATURES FITTED
(MARKET DEPENDENT)**





EXTERIOR VIEW

FULL WIDTH PANORAMIC ROOF

The view from inside XJ is extensive: a panoramic, full width, heat-reflective glass roof sweeps back and over the rear seats. It filters UV rays and floods the interior with natural light making it feel airy, spacious and, thanks to effective tinting, very private. Power operated blinds allow you to completely block the light when required. Specially formulated toughened glass helps to keep the cabin cool.

VEHICLE SHOWN: XJ PORTFOLIO LONG WHEELBASE IN QUARTZITE WITH OPTIONAL FEATURES FITTED
(MARKET DEPENDENT)





INTERIOR TECHNOLOGY

 **CONNECTED INFOTAINMENT** | **ADVANCED GRAPHICS**

XJ's high-definition Instrument Panel Display puts everything you need to know about your driving right in front of you. The 12.3 inch screen displays the speed, fuel and temperature gauges and can be set to display the most relevant information, depending on the situation and set up. This multi-layered virtual display combines a user-friendly graphical interface with advanced functionality to make finding the right settings even easier.

The Instrument Panel Display is fully integrated with the 8 inch Touch-screen to put all information behind the wheel or on the centre console. For example, when working with InControl Touch Pro Guidance the Instrument Panel Display can be reconfigured to show 3D mapping, making following your route even simpler.

Standard and optional features may differ depending on market availability. Please consult your local Jaguar retailer for details.

INTERIOR SHOWN: XJ PORTFOLIO LONG WHEELBASE SHOWING IVORY SOFT GRAIN PERFORATED LEATHER SEATS WITH JET CONTRAST STITCH, JET UPPER FACIA, JET SUEDECLOTH HEADLINING AND GLOSS RICH OAK VENEER WITH OPTIONAL FEATURES FITTED (MARKET DEPENDENT)

INTERIOR LUXURY

 CRAFTSMANSHIP | EXTENSIVE CHOICE

The quality of craftsmanship throughout the XJ cabin sets it apart. With a wide choice of colours, materials and finishes, the interior reflects the clarity and purity of XJ's exterior. The hand-crafted veneer that runs right around the cabin accentuates the sense of space. Jaguar's sporting character is present in the controls and architecture surrounding the driver including the leather-wrapped, three-spoke steering wheel that offers key controls at your fingertips.

INTERIOR SHOWN: XJ PORTFOLIO LONG WHEELBASE WITH OPTIONAL PREMIUM REAR SEAT PACK SHOWING IVORY SOFT GRAIN PERFORATED LEATHER SEATS WITH JET CONTRAST STITCH, JET UPPER FACIA, JET SUEDECLOTH HEADLINING AND GLOSS RICH OAK VENEER WITH OPTIONAL FEATURES FITTED (MARKET DEPENDENT)







INTERIOR COMFORT



**FRONT PASSENGER
SEAT AWAY**

**HEATING AND
COOLING FUNCTIONS**

**FIVE MASSAGE
PROGRAMMES**

XJ's multi-functional seating gives you complete control of your comfort. Both front seats feature fine-tuned electric adjustment and can be specified with five different massage programmes. Both front and rear seats are heated. All seats feature a cooling function as well (excluding XJ Luxury model). Some XJ models also offer three position user memory on the driver and front passenger seats. Long Wheelbase models can be further enhanced with a choice of Rear Seat Option Packs, featuring two individual airline-style reclining seats complete with three massage programmes and memory. The reclining rear seats can be programmed to return to an upright position when the door is opened and a 'front passenger seat away' function allows rear occupants to move the empty front passenger seat forward to increase legroom and aid access.

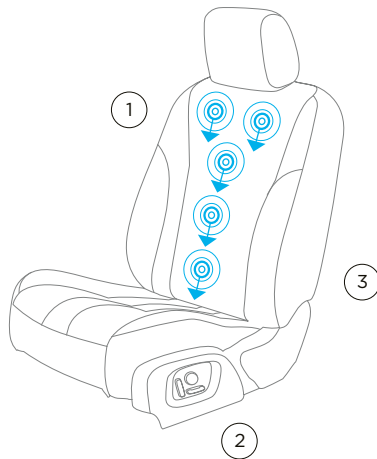

FRONT SEATS

Available with five different massage programmes, electric adjustment with three position memory and heated/cooling function.

1. Five massage programmes
2. Three position memory function
3. Cooling function

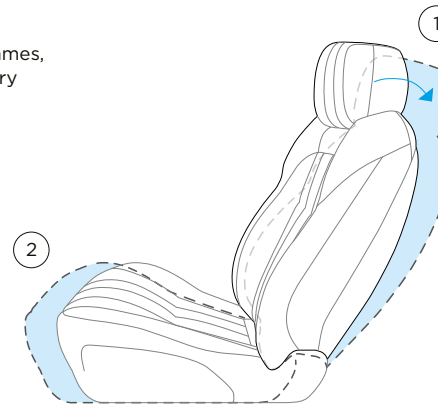

REAR SEATS

Available on Long Wheelbase models with airline-style recline, three different massage programmes, electric adjustment with two position memory.

1. Total recline movement is 11 degrees
2. 103mm of longitudinal cushion movement and separate 14.5 degrees of upper articulation movement

Standard and optional features may differ depending on market availability. Please consult your local Jaguar retailer for details.

INTERIOR SHOWN: XJ PORTFOLIO LONG WHEELBASE WITH OPTIONAL PREMIUM REAR SEAT PACK SHOWING IVORY SOFT GRAIN PERFORATED LEATHER SEATS WITH JET CONTRAST STITCH, JET UPPER FACIA, JET SUEDECLOTH HEADLINING AND GLOSS RICH OAK VENEER WITH OPTIONAL FEATURES FITTED (MARKET DEPENDENT)





1. LWB headroom 960mm 2. LWB knee room 189mm

INTERIOR SPACE



OVER A METRE OF LEGROOM

LIMOUSINE RIDE

Long Wheelbase (LWB) models feature over a metre of legroom for rear seat passengers providing the perfect environment to work, enjoy a host of entertainment options, or simply stretch out and relax. Long Wheelbase models also feature a unique 'limousine' ride with revised air suspension settings for even more refined comfort.

Depending on the model, or options chosen, the rear cabin can be further enhanced with individual 10.2 inch HD screens. The centre armrest houses the multimedia remote and front and rear seat controls, as well as providing useful storage. Folding business tables, LED reading lights, drop-in footrests and electric side rear window blinds are also available to add comfort, convenience and privacy.

Standard and optional features may differ depending on market availability. Please consult your local Jaguar retailer for details.

INTERIOR SHOWN: XJ PORTFOLIO LONG WHEELBASE WITH OPTIONAL PREMIUM REAR SEAT PACK SHOWING IVORY SOFT GRAIN PERFORATED LEATHER SEATS WITH JET CONTRAST STITCH, JET UPPER FACIA, JET SUEDECLOTH HEADLINING AND GLOSS RICH OAK VENEER WITH OPTIONAL FEATURES FITTED (MARKET DEPENDENT)

PERFORMANCE ENGINES



STOP/START TECHNOLOGY

EFFICIENT DIESEL ENGINE

XJ offers a choice of a V6 Turbocharged diesel engine or five petrol engines. Petrol engines range from the 2.0 litre 4 cylinder 240PS Turbocharged to the 3.0 litre V6 Supercharged and XJR's powerful 5.0 litre V8 550PS Supercharged. All engines feature Intelligent Stop/Start to further improve XJ's fuel efficiency and reduce CO₂ emissions. For information on fuel consumption, CO₂ emissions and performance figures for XJ engines, please refer to pages 78 to 79.



DIESEL ENGINE FROM

149g/km CO₂

The 300PS 3.0 litre V6 Turbocharged Diesel engine offers exceptional refinement and efficiency, including an impressive torque figure of up to 700Nm for improved performance and excellent drivability. Its high pressure common rail fuel system delivers efficient combustion and fewer emissions. The engine uses innovative twin parallel sequential turbocharging - a concept pioneered by Jaguar Land Rover - for smooth, more immediate delivery of power at all engines speeds. It is capable of 0-100km/h in 6.2 seconds with CO₂ emissions of just 149-155g/km** CO₂ (5.7-5.9 l/100km*) on the European Combined Cycle.

The engine uses an 8-speed automatic transmission and also includes Stop/Start technology.

Engine availability is market dependent. Please consult your local Jaguar retailer for details.

*5.7 refers to 19" wheels and 5.9 refers to 20" wheels. **149 refers to 19" wheels and 155 refers to 20" wheels.

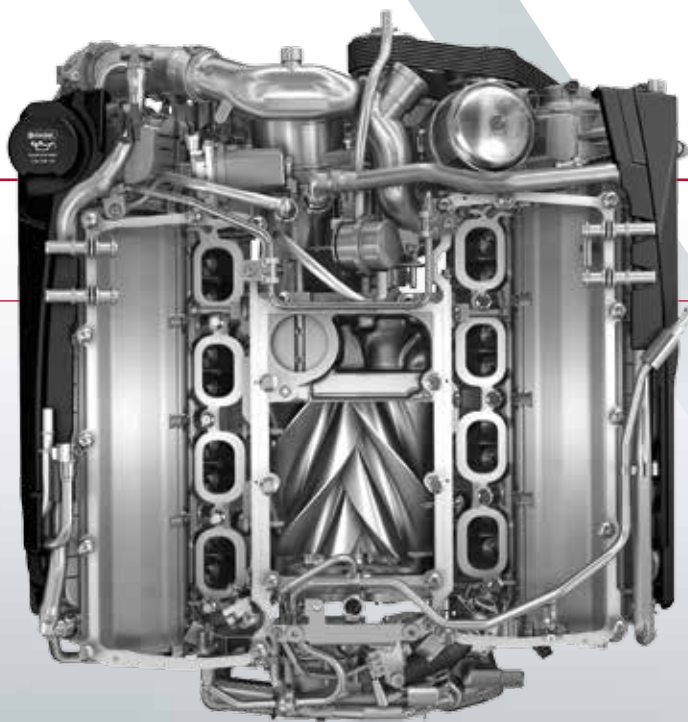

PETROL ENGINES UP TO

0-100km/h in 4.6 sec

A choice of five petrol engines means that you can select the ideal engine to suit your driving style. Our 2.0 litre 4 cylinder 240PS Turbocharged engine offers economy and performance, achieving 0-100km/h in 7.9 seconds due to its 340Nm of torque, yet can consume as little as 8.4 l/100km and produce CO₂ emissions as low as 199g/km. The 3.0 litre V6 Supercharged Petrol engine includes a Roots-type supercharger, which is mounted in the 'V' between the two rows of cylinders for compact dimensions. Supercharging provides linear delivery of power and maximises responsiveness. This results in performance matching much larger engines, while optimising economy and reducing emissions. The 470PS, 510PS and 550PS 5.0 litre V8 Supercharged engines are all engineered for smoothness, power and incredible performance.

ALL-ALUMINIUM BODY



AGILITY ENHANCED

ECONOMY IMPROVED

100% ALUMINIUM

XJ's all-aluminium body, the core of its dynamic performance, creates a stiffer, stronger and, most importantly, lighter architecture. Developed using aerospace bonding and riveting techniques, XJ's 100 percent aluminium monocoque body structure does not have a single welded joint. With up to 50 percent of XJ's aluminium coming from recycled sources, XJ leads the way in sustainability.

One of the lightest cars in its class, XJ's excellent power-to-weight ratio improves all aspects of performance with no compromise to its strength. Acceleration is improved, and because the engine has to work less hard, it lowers fuel consumption and emissions. Its aluminium construction also enhances ride comfort, handling, agility and feel, connecting the driver seamlessly to the car and the road.

The inherent strength of aluminium and the monocoque construction offer safety benefits too. The lower weight improves braking performance and reduces the kinetic energy involved in any impact. Aluminium absorbs significantly more energy than steel when it is deformed and, because there are fewer joints, XJ's strength is increased further still.

VEHICLE SHOWN: XJ AUTOBIOGRAPHY LONG WHEELBASE IN DARK SAPPHIRE WITH OPTIONAL FEATURES FITTED (MARKET DEPENDENT)





ADVANCED DRIVING DYNAMICS



AIR SUSPENSION SYSTEM

ADAPTIVE DYNAMICS

XJ delivers the comfort and refinement of a luxury car with the responsiveness and driver involvement of a sports car. Whether you're cornering, navigating uneven surfaces or accelerating, XJ's Adaptive Dynamics system continually monitors the car up to 500 times a second. Working in conjunction with the air suspension it constantly varies the damping to suit the conditions. These intelligent adjustments keep XJ flat and stable, improving control without loss of ride comfort. In unexpected road and weather conditions, Dynamic Stability Control (DSC) reacts as soon as the system detects the wheels slipping. Trac DSC provides a sportier drive and assists when using snow chains by allowing some slippage or overspin before the system engages. XJ also features selectable driving modes for specific performance requirements. In addition to 'Drive' and 'Sport', Dynamic Mode gives more responsive acceleration; Winter Mode delivers more progressive control in slippery conditions.

VEHICLE SHOWN: XJ PORTFOLIO LONG WHEELBASE IN QUARTZITE WITH OPTIONAL FEATURES FITTED (MARKET DEPENDENT)













XJR - PERFORMANCE AND LUXURY



5.0 LITRE SUPERCHARGED V8

ELECTRONIC ACTIVE DIFFERENTIAL

XJR combines supercar performance with luxury and exemplifies the pinnacle of Jaguar's engineering, design and craftsmanship: from its muscular lines to the 5.0 litre Supercharged V8 engine, which is tuned and calibrated to produce a top speed of 280km/h. This is a luxury saloon car that can accelerate from 0-100km/h in 4.6 seconds. XJR's 550PS power and outstanding 680Nm of torque deliver a thrilling driving experience.

XJR's performance driving dynamics are assisted by the Electronic Active Differential allowing for very fine control of the power delivery to limit wheelspin, maximise traction and offer greater levels of control. Working in conjunction with the stability, traction and ABS systems, the Electronic Active Differential uses an electric motor, acting on a multi-plate clutch to manage the delivery of torque to each of the rear wheels. Full electronic control of the rear differential lock enables the system to apply full locking torque almost instantaneously.

XJR's aerodynamics are sharpened with a revised front bumper, splitter and lower air intakes with chrome surrounds, side sills and a rear spoiler. Its unique exterior styling includes a gloss black grille, twin bonnet louvres, red brake calipers, signature 'R' badging and 20 inch Farallon alloy wheels. The optional Black Pack can add even more visual drama and features gloss black grille and lower air intake surrounds, side power vents and window finishers.

VEHICLE SHOWN LEFT AND PREVIOUS PAGE: XJR STANDARD WHEELBASE IN GLACIER WHITE WITH OPTIONAL FEATURES FITTED (MARKET DEPENDENT)



XJR - SPORTING STYLE

> FIVE COLOURWAYS | UNIQUE 'R' INTERIOR

Inside, XJR blends sporting character with luxury. The soft grain leather upholstery is offered in five bold colourways, including the unique Jet/Red duotone, and is complemented with either Piano Black or Carbon Fibre veneers. Sports seats feature adjustable side bolsters that provide the driver and passenger with lateral support during hard cornering.

The 'R' logo appears on the steering wheel, dashboard Intaglio and is embossed on the front and rear seats. XJR offers a combination of sporting style, contemporary luxury and true performance.

VEHICLE SHOWN: XJR INTERIOR WITH JET/RED DUOTONE SOFT GRAIN LEATHER SPORTS SEATS WITH RED CONTRAST STITCH, JET UPPER FACIA, JET SUEDECLOTH HEADLINING, PIANO BLACK VENEER AND JET PREMIUM CARPET MATS WITH RED CONTRAST BINDING WITH OPTIONAL FEATURES FITTED (MARKET DEPENDENT)



DRIVING TECHNOLOGY

ALL SURFACE PROGRESS CONTROL



ADDED DRIVER CONFIDENCE

LOW SPEED CRUISE CONTROL

Standard on every XJ, Jaguar's All Surface Progress Control (ASPC) technology is a low speed cruise control that helps the car to cope with low traction situations. ASPC allows the driver to concentrate on steering the vehicle. Once activated, you use the cruise control buttons to set a 'target' speed of between 3.6km/h and 30km/h. The system then works to achieve and maintain that speed while exerting optimum traction control. ASPC gives XJ drivers added confidence over slippery, loose or icy surfaces, undulating terrain and even while descending a difficult incline. It helps make XJ easy to drive in challenging conditions.

With any given set of tyres, ASPC can accomplish comparable levels of traction to that achievable by an expert driver. Fitting All Season or Winter tyres to XJ can improve capability on slippery surfaces.



GRAVEL



WET GRASS



SNOW/ICE



WET ROAD

ADVANCED DRIVETRAIN TECHNOLOGY



ALL WHEEL DRIVE

OVER 90% TORQUE SPLIT

INTELLIGENT AND ADAPTIVE

The optional Jaguar All Wheel Drive (AWD) system is continuously variable and intelligent. The rear wheel bias ensures a consistently true Jaguar driving experience. In normal conditions an XJ with the AWD system behaves like a rear wheel drive vehicle but reacts intelligently to road conditions to deliver traction on demand. The AWD system reacts in the blink of an eye, so should the rear wheels start to slip, it instantly redistributes torque to compensate. Over 90 percent of engine torque can be distributed from the rear wheels to the front wheels to provide optimum traction. As well as offering a smoother, safer drive with the familiar Jaguar agility and handling, it also consumes less fuel and has lower emissions than a permanent AWD system.

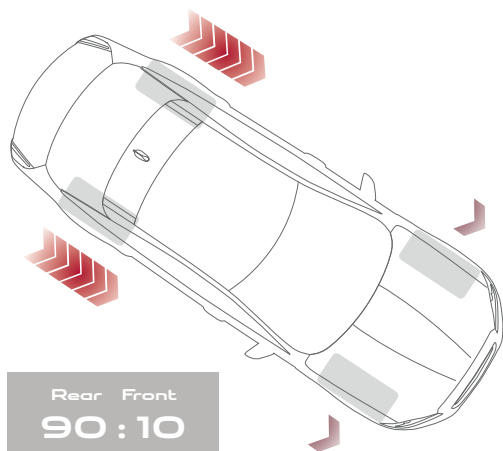

DRY ROAD CONDITIONS

In normal driving conditions, virtually all torque is distributed to the rear wheels providing signature Jaguar rear wheel drive performance.

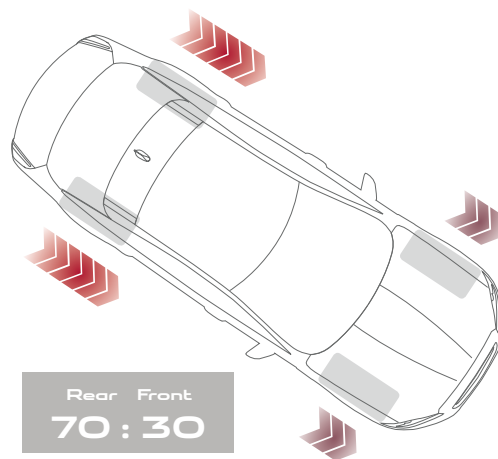

AWD WINTER MODE

At the touch of a button AWD Winter Mode can be selected to distribute 30 percent of the torque to the front wheels and 70 percent of the torque to the rear wheels maximising control in difficult conditions.

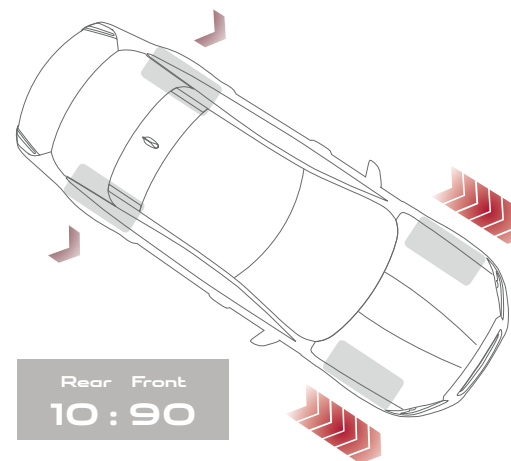

VARIABLE ROAD CONDITIONS

Where road conditions are changeable, over 90 percent of torque can be distributed to the front wheels as required to ensure optimum traction.

Standard and optional features may differ depending on market availability. Please consult your local Jaguar retailer for details.

VEHICLE SHOWN: XJ AUTOBIOGRAPHY LONG WHEELBASE IN DARK SAPPHIRE WITH OPTIONAL FEATURES FITTED (MARKET DEPENDENT)



INFOTAINMENT INCONTROL TECHNOLOGIES



INCONTROL TOUCH PRO

INCONTROL CONNECT PRO

InControl is our suite of advanced technologies that links both you and your XJ to the wider world. XJ features the InControl Touch Pro infotainment system. This can be further enhanced by adding its connectivity package: InControl Connect Pro.

INCONTROL TOUCH PRO



STANDARD

- 8 inch Touch-screen with multi-touch gestures and customisable home screen
- 12.3 inch Instrument Panel Display with virtual dials and full screen 3D Map View
- InControl Touch Pro Solid State Drive (SSD)
- Enhanced Navigation
- FM Radio, Bluetooth® and 2 x USB connections
- 10GB of usable memory
- CD/DVD Drive

OPTIONAL FEATURES



InControl Protect consists of SOS Emergency Call, Jaguar Optimised Assistance and Remote Essentials smartphone app



InControl Connect Pro consists of InControl Apps, Remote Premium smartphone app, Wi-Fi Hotspot and Pro Services



InControl Secure provides Stolen Vehicle Monitoring and notifications via your smartphone and the secure call centre



For information on InControl Connect Pro see page 43.

InControl features, options and their availability remain market dependent – check with your Retailer for local market availability and full terms. Certain features require a Micro SIM with a suitable data contract which will require further subscription after the initial term advised by your Retailer.

VEHICLE SHOWN: XJ PORTFOLIO LONG WHEELBASE IN QUARTZITE WITH OPTIONAL FEATURES FITTED (MARKET DEPENDENT)





SWIPE



PINCH



ZOOM



VOICE
ACTIVATION

INCONTROL TOUCH PRO

NEXT GENERATION INFOTAINMENT

InControl Touch Pro's next-generation hardware and software advances XJ's connectivity and entertainment to the very highest level. The key aspects of InControl Touch Pro are:

Large, highly-responsive, 8 inch Touch-screen at the heart of the centre console with customisable home screen and lightning fast response times.

Pinpoint touch control allows you to manipulate and interact with information swiftly and seamlessly. The Touch-screen responds in the same manner as a smartphone or tablet computer, providing multi-touch gestures such as pinch, zoom and swipe.

12.3 inch Instrument Panel Display with virtual dials and full screen 3D Map View makes driving even more of a pleasure. Select full screen 3D map view or choose one of four graphical themes to suit your personal preference.

Solid State Drive Enhanced Navigation with response times that are a fraction of conventional systems. Set a destination and the system alerts you if you have insufficient fuel for the journey. It then displays filling stations on the part of the route where you may be low on fuel. The system automatically displays parking options.

Personal media storage of 10GB for your music and movies. 'Plug and play' using the two USB ports allowing for fast transfer speeds.



Explore InControl at jaguar.com/incontrol

InControl features, options and their availability remain market dependent - check with your Retailer for local market availability and full terms. Certain features require a Micro SIM with a suitable data contract which will require further subscription after the initial term advised by your Retailer.

INCONTROL CONNECT PRO

OPTIONAL ENHANCED CONNECTIVITY PACKAGE

InControl Connect Pro's services, technologies and applications give you the very best in connectivity and convenience. It offers many features including:

InControl Apps features a range of Jaguar approved apps that can be connected to XJ from your smartphone. It ensures safe and convenient use of apps optimised to enhance aspects of your in-car experience.

Remote Premium is an app that allows you to monitor as well as interact with your XJ from your smartphone. Remote start XJ to pre-condition the climate, lock and unlock the car, locate your XJ on a map or using the beep and flash function, and track your journeys.

Wi-Fi Hotspot gives you the option to create a strong 3G hotspot using the car's antenna when you fit a SIM card. Connect up to eight devices to read emails, browse the web and download content.

Route Planner Companion App allows you to pre-plan your route via your Apple or Android smartphone. It guides you to your car, where you will find your selected route available on XJ's Touch-screen. When you've completed your road journey, the app guides you to your destination.

Pro Services is a comprehensive suite of connected services that includes:

Share your estimated time of arrival so your selected contact(s) will know when you will arrive, as calculated by the navigation guidance system. The system can then send automatic updates via text or email, without any further action from you.

Commute Mode allows the system to learn your commutes and automatically advises you of the expected journey time and quickest routes based on live and historical traffic movements.

Arrival Mode displays interactive 360 degree street level imagery of your destination for a seamless finish to journeys. It automatically displays again upon your arrival.

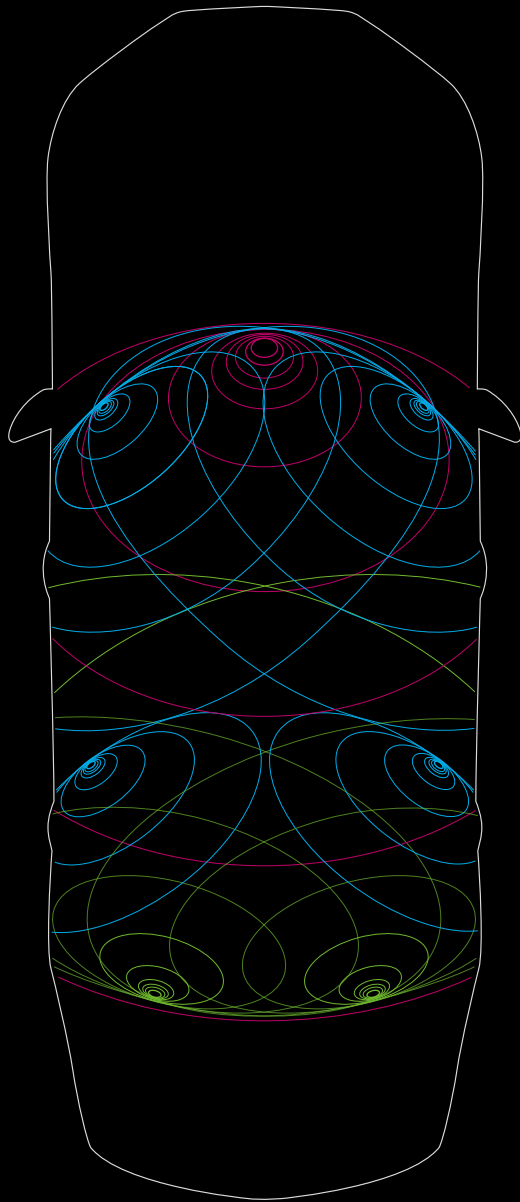

AUDIO



MERIDIAN

TRIFIELD™

CONVERSATION ASSIST

XJ's superb sound systems bring your music to life. Through their use of advanced Audyssey MultEQ sound equalisation technology, all these sound systems deliver accurate and enveloping sound. The Jaguar Sound System provides acoustic range through 12 speakers. Offering an enhanced listening experience are the optional Meridian Sound Systems.

Designed for XJ by Meridian, the British audio experts, three fully Digital systems are available: the Meridian 380W Digital Sound System, the Meridian 825W Digital Surround Sound System and the Meridian Reference 1300W Digital Sound System. All feature advanced technology including Digital Sound Processor (DSP) software to create high fidelity sound throughout the cabin and optimise every element of the system, as well as Meridian Cabin Correction (MCC) to improve the clarity and authentic reproduction of your music.

The Meridian 380W Digital Sound System has 14 speakers, including a dual-coil subwoofer and 2 x 8 inch front door woofers for a seminal audio experience. The Meridian 825W Digital Surround Sound System uses 20 speakers including the dual-coil subwoofer to produce 7.1 surround sound ensuring a perfect stereo image for each occupant wherever they are seated.

The latest addition to the range is the Meridian Reference 1300W Digital Sound System using 26 speakers. This ultra-premium sound system employs Psychoacoustics to produce sounds that are so true to life they are perceived by the brain as the real thing.

Now you can hold a meeting or have an informal chat without ever having to raise your voice. Conversation Assist, included as standard with the Meridian Reference 1300W Digital Sound System, allows the driver or front seat passenger to talk with ease to passengers in the rear of the car, and vice versa. Microphones above each seat reinforce the occupants' voices via the audio system's speakers, making it much easier for everyone to be heard.

- Holographic Centre Image
- Door Waves: Tweeter, Midrange & Bass
- Surround Sound Waves

Diagram representative of Meridian 825W Digital Surround Sound System.



MERIDIAN



250 WATTS
12 SPEAKERS
8 AMPLIFIER CHANNELS

JAGUAR SOUND SYSTEM
 250W*,
 12 speakers,
 8 channel amplifier,
 Audyssey MultEQ Audio Equalisation



380 WATTS
14 SPEAKERS
12 AMPLIFIER CHANNELS

MERIDIAN DIGITAL SOUND SYSTEM
 380W*,
 14 speakers,
 12 channel class D DSP amplifier,
 Audyssey MultEQ Audio Equalisation,
 Dynamic volume control



825 WATTS
20 SPEAKERS
15 AMPLIFIER CHANNELS

MERIDIAN DIGITAL SURROUND SOUND SYSTEM
 825W*,
 20 speakers,
 15 channel class D DSP amplifier,
 Audyssey MultEQ Audio Equalisation,
 7.1 Surround Sound,
 Trifield technology



1300 WATTS
26 SPEAKERS
17 AMPLIFIER CHANNELS

MERIDIAN REFERENCE DIGITAL SURROUND SOUND SYSTEM
 1300W*,
 26 speakers,
 17 channel class D DSP amplifier,
 Audyssey MultEQ Audio Equalisation,
 7.1 Surround Sound,
 Trifield technology,
 Conversation Assist

Standard and optional features may differ depending on market availability. Please consult your local Jaguar retailer for details.

*Trifield' and the 'three fields' device are trademarks of Trifield Productions Ltd.

*0.2% THD (Total Harmonic Distortion)

SAFETY AND EFFICIENCY

ADVANCED DRIVER ASSISTANCE

XJ is equipped with an array of standard and optional driver assistance systems dependent on model chosen. All are designed to make driving easier and safer.



- ① **360° PARK DISTANCE CONTROL**
360° Park Distance Control uses ultrasonic sensors to the front, rear and sides of the vehicle to alert you to the proximity of objects when parking or exiting from a bay.



- ② **ADAPTIVE FRONT LIGHTING**
Adaptive Front Lighting adapts to steering inputs to cast a deeper beam into corners, while its Intelligent High Beam senses oncoming vehicles and automatically selects high or dipped beam as appropriate.



- ③ **ADVANCED SAFETY SYSTEMS**
Advanced safety systems actively protect everyone on board XJ with advanced airbag technology. The Pedestrian Contact Sensing System can reduce injuries to pedestrians in case of a collision.



- ④ **TRAFFIC SIGN RECOGNITION**
Traffic Sign Recognition technology can detect current speed limit signs to display them on the Instrument Panel Display. This smart system is also aware of local and conditional speed limits.



- ⑤ **BLIND SPOT MONITOR WITH CLOSING VEHICLE SENSING AND REVERSE TRAFFIC DETECTION**
Blind Spot Monitor warns you of vehicles or obstacles beside XJ, while Closing Vehicle Sensing looks out for following vehicles approaching XJ from a distance. Both provide alerts via an icon displayed in the appropriate exterior mirror. Reverse Traffic Detection alerts you, via an audio alert and the Touch-screen, of moving vehicles during reversing - for example, when leaving a parking bay with restricted vision.



- ⑥ **PARK ASSIST***
Park Assist makes life in the city easier. The system works for both parallel and perpendicular parking and automatically steers XJ into and out of a space while the driver operates the pedals.

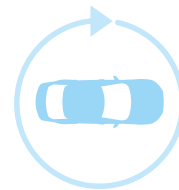

- ⑦ **SURROUND CAMERA SYSTEM**
The Surround Camera system gives you multiple views around the vehicle from four cameras, shown on the central Touch-screen. This helps with various manoeuvres, from parking by a kerb to getting in and out of tight spaces and junctions.

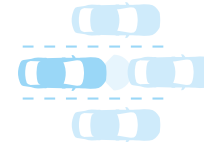

- ⑧ **ADAPTIVE CRUISE CONTROL WITH QUEUE ASSIST**
Adaptive Cruise Control with Queue Assist senses when a vehicle in front slows and reduces XJ's speed accordingly to maintain a safe distance. When the vehicle speeds up again, so does XJ.

Standard and optional features may differ depending on market availability. Please consult your local Jaguar retailer for details.

*Available on Rear Wheel Drive (RWD) models only.

VEHICLE SHOWN: XJ PORTFOLIO LONG WHEELBASE IN AMMONITE GREY WITH OPTIONAL FEATURES FITTED (MARKET DEPENDENT)

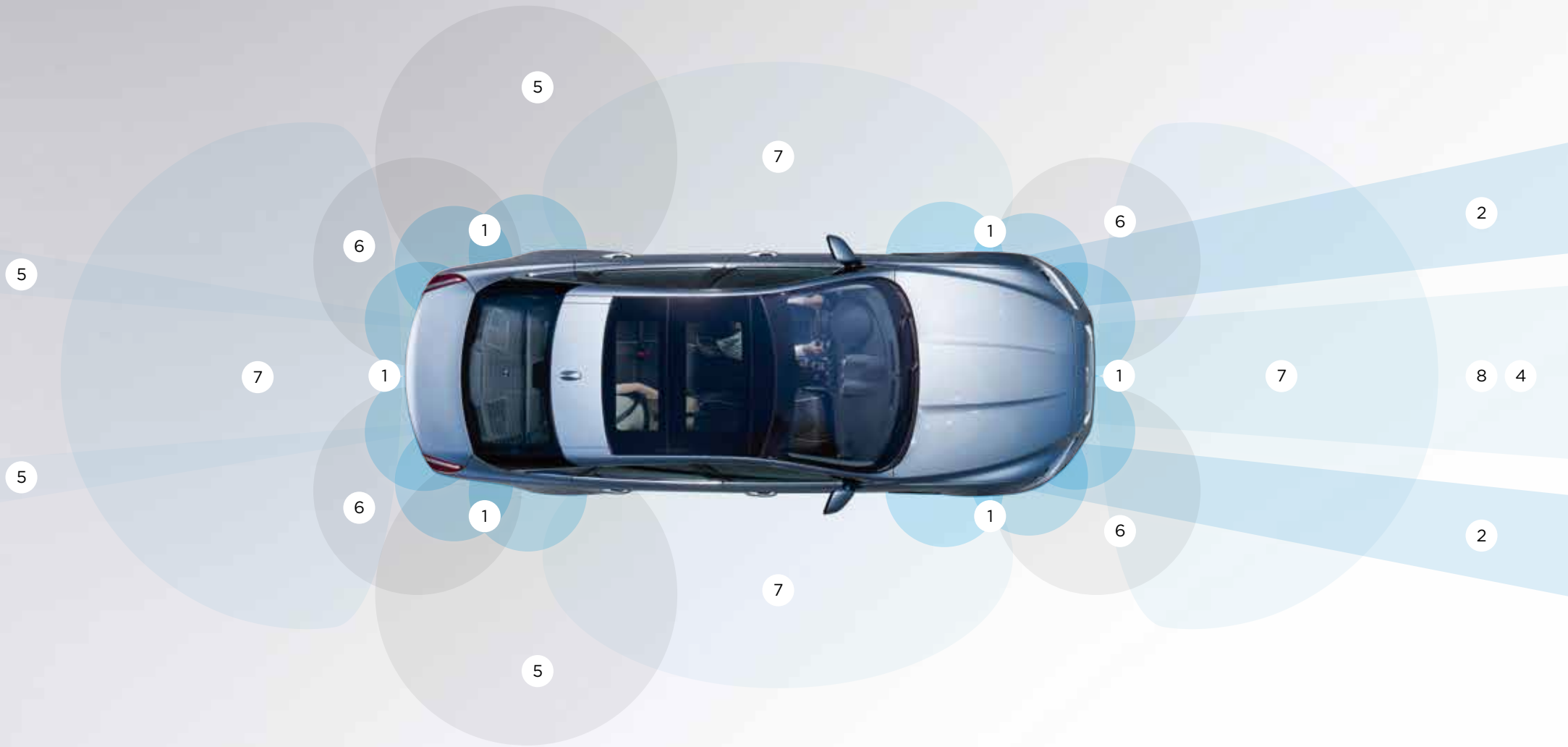

Graphical representation only.

EFFICIENT TECHNOLOGIES

 **STOP/START TECHNOLOGY** | **CLEAN TECHNOLOGIES**

We are determined to do more with less. That is why XJ uses a range of technologies to reduce fuel consumption and CO₂ emissions, all while staying true to Jaguar's dynamic nature.



STOP/START TECHNOLOGY

All XJ engines utilise Stop/Start technology. It shuts down the engine when you come to a complete halt and restarts the engine immediately when required, helping to save fuel, especially during urban driving.

Standard and optional features may differ depending on market availability. Please consult your local Jaguar retailer for details.



ELECTRIC POWER ASSISTED STEERING (EPAS)

XJ's next generation Electric Power Assisted Steering (EPAS) offers outstanding feedback, control and immediate power assistance. Electrically driven, it's only active on demand which saves fuel. Only available on rear wheel drive vehicles.



AERODYNAMICS

XJ's highly efficient shape is the result of hundreds of thousands of hours of Computational Fluid Dynamics testing. Jaguar created one of the world's most advanced automotive virtual testing labs, honing XJ's shape through virtual wind tunnels to slice through wind resistance.

AdBlue®

ADBLUE

XJ's diesel engine is fitted with AdBlue to help clean exhaust gases. AdBlue is a non-toxic, non-flammable, biodegradable additive that processes the gases in the car's exhaust system to remove harmful nitrogen oxide emissions.



ALUMINIUM ARCHITECTURE

XJ's All-Aluminium architecture makes it one of the lightest vehicles in its class, meaning less fuel is needed to move it and consequently creating lower emissions. With up to 50 percent of the aluminium used coming from recycled sources, XJ's green credentials are assured.

PERSONALISATION XJ - YOUR CHOICE

 Configure your vehicle at jaguar.com



CHOOSE YOUR ENGINE

Page 52

Select one of XJ's powerful, efficient petrol or diesel engines to suit your driving style.

CHOOSE YOUR MODEL

Page 54

Compare the wealth of standard features on XJ models.

CHOOSE YOUR COLOUR

Page 56

Express your individuality with one of XJ's stunning exterior colours.



CHOOSE YOUR
WHEELS

Page 58

Add the personal finishing touch to your new XJ, and complement its stunning style, with a set of beautifully designed alloy wheels.



CHOOSE YOUR
INTERIOR

Page 60

There's a wide selection of premium materials, leathers, veneers and finishes for every personal taste.



CHOOSE YOUR
**JAGUAR
ACCESSORIES**

Page 76

Really make it yours by adding style, practicality and versatility with official XJ accessories from your local Jaguar retailer.

1 CHOOSE YOUR ENGINE

 Configure your vehicle at jaguar.com

PETROL ENGINES

2.0 LITRE

4 CYLINDER

TURBOCHARGED PETROL

MAXIMUM POWER 240PS

MAXIMUM TORQUE 340Nm

ACCELERATION 0-100km/h 7.9 seconds

TOP SPEED 241km/h

COMBINED 8.4 l/100km*

CO₂ EMISSIONS 199g/km



0-100 KM/H

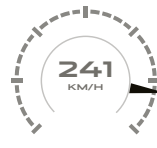

TOP SPEED KM/H

3.0 LITRE V6

TURBOCHARGED PETROL

MAXIMUM POWER 340PS

MAXIMUM TORQUE 450Nm

ACCELERATION RWD 0-100km/h 5.9 seconds

AWD 0-100km/h 6.4 seconds

TOP SPEED 250km/h

COMBINED RWD 9.1 l/100km* / AWD 9.8 l/100km*

CO₂ EMISSIONS RWD 211g/km / AWD 234g/km



RWD
0-100 KM/H

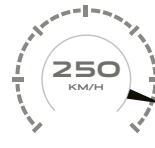

RWD
TOP SPEED KM/H



AWD
0-100 KM/H



AWD
TOP SPEED KM/H

5.0 LITRE V8

SUPERCHARGED PETROL

MAXIMUM POWER 470PS

MAXIMUM TORQUE 575Nm

ACCELERATION 0-100km/h 5.2 seconds

TOP SPEED 250km/h

COMBINED 11.1 l/100km*

CO₂ EMISSIONS 264g/km



0-100 KM/H

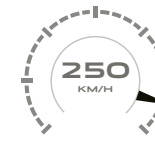

TOP SPEED KM/H

Engine availability is market dependent. Please consult your local Jaguar retailer for details.

*Official EU test figures. For comparison purposes only. Real world figures may differ. Refer to Technical Specification pages for full fuel consumption figures.

> DIESEL ENGINE

5.0 LITRE V8 SUPERCHARGED PETROL

MAXIMUM POWER 510PS
MAXIMUM TORQUE 625Nm
ACCELERATION 0-100km/h 4.9 seconds
TOP SPEED 250km/h
COMBINED 11.1 l/100km
CO ₂ EMISSIONS 264g/km

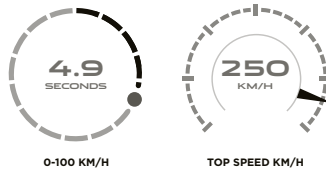

5.0 LITRE V8 SUPERCHARGED PETROL

MAXIMUM POWER 550PS
MAXIMUM TORQUE 680Nm
ACCELERATION 0-100km/h 4.6 seconds
TOP SPEED 280km/h
COMBINED 11.1 l/100km*
CO ₂ EMISSIONS 264g/km

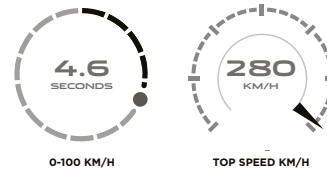

3.0 LITRE V6 TURBOCHARGED DIESEL

MAXIMUM POWER 300PS
MAXIMUM TORQUE 700Nm
ACCELERATION 0-100km/h 6.2 seconds
TOP SPEED 250km/h
COMBINED 5.7 l/100km*
CO ₂ EMISSIONS 149g/km

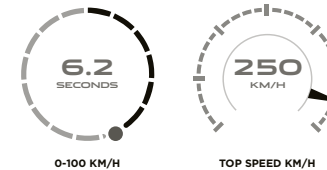

2 CHOOSE YOUR MODEL

 Configure your vehicle at jaguar.com

> LUXURY



LUXURY

KEY FEATURES

- 14 Way Seats with Lumbar Adjustment
- Heated Front and Rear Seats
- Carpet Mat Set
- Satellite Navigation System
- Jaguar Sound System (250W)
- Dual-Zone Climate Control
- Bluetooth® Audio and Video Streaming
- Front and Rear Parking Aid
- All Surface Progress Control
- Twin Oval Exhausts
- Chrome Grille with Chrome Surround
- Chrome Side Power Vent
- Xenon Headlights



PREMIUM LUXURY

KEY FEATURES

(IN ADDITION TO 'LUXURY')

- Heated and Cooled Front and Rear Seats
- Soft Door Close and Keyless Entry
- Power Fold Exterior Mirror
- Meridian Digital Sound System (380W)



PORTFOLIO

KEY FEATURES

(IN ADDITION TO 'PREMIUM LUXURY')

- 18 Way Seats with Lumbar Adjustment
- Front Seat with Five Massage Programmes
- Extended range of interior trim themes
- Premium Carpet Mat Set
- Four-Zone Climate Control
- Meridian Digital Surround Sound System (825W)
- Full LED Headlights



AUTOBIOGRAPHY

KEY FEATURES

(IN ADDITION TO 'PORTFOLIO')

- LED Rear Reading Lights
- Illuminated Tread Plates
- Metallic Foot Pedals
- Full LED Headlights with Adaptive Lighting and Automatic High Beam Assist
- Surround Camera System
- Closing Vehicle Sensing with Blind Spot Monitoring and Reverse Traffic Detection
- 360° Park Distance Control
- Park Assist - Parallel, Bay and Exit

Images feature optional equipment.
Please note that standard features may be replaced when selecting alternative trim levels.
Standard features may also vary depending on country of purchase, engine variant and transmission.
Standard and optional features may differ depending on market availability. Please consult your local Jaguar retailer for details.

> SPORT



R-SPORT

**KEY FEATURES
(IN ADDITION TO 'PREMIUM LUXURY')**

R-Sport Front and Rear Tread Plates
Metallic Foot Pedals
Premium Carpet Mat Set
Four-Zone Climate Control
Gloss Black Front Grille and Rear Valance
Rear Spoiler, Side Sills and Front Splitter
Meridian Digital Surround Sound System (825W)
Full LED Headlights



XJR

**KEY FEATURES
(IN ADDITION TO 'R-SPORT')**

'R' Front and Rear Tread Plates
XJR Quad Pipe Exhaust Finishers
Red Painted Brake Calipers with Jaguar Script
XJR Bonnet Louvres
Body Coloured Rear Valance
XJR Sports Exhaust System
XJR Suspension
Active Differential

3 CHOOSE YOUR COLOUR

 [Configure your vehicle at jaguar.com](https://www.jaguar.com)

SOLID

Polaris White

Ebony

METALLIC

Glacier White

Rhodium Silver

Quartzite

Ammonite Grey

Caesium Blue

Dark Sapphire

Odyssey Red

Aurora Red



PREMIUM METALLIC

Italian Racing Red

British Racing Green

Ultimate Black

Ingot

Gallium Silver

Tempest Grey

Storm Grey

Black Berry

Cosmic Black

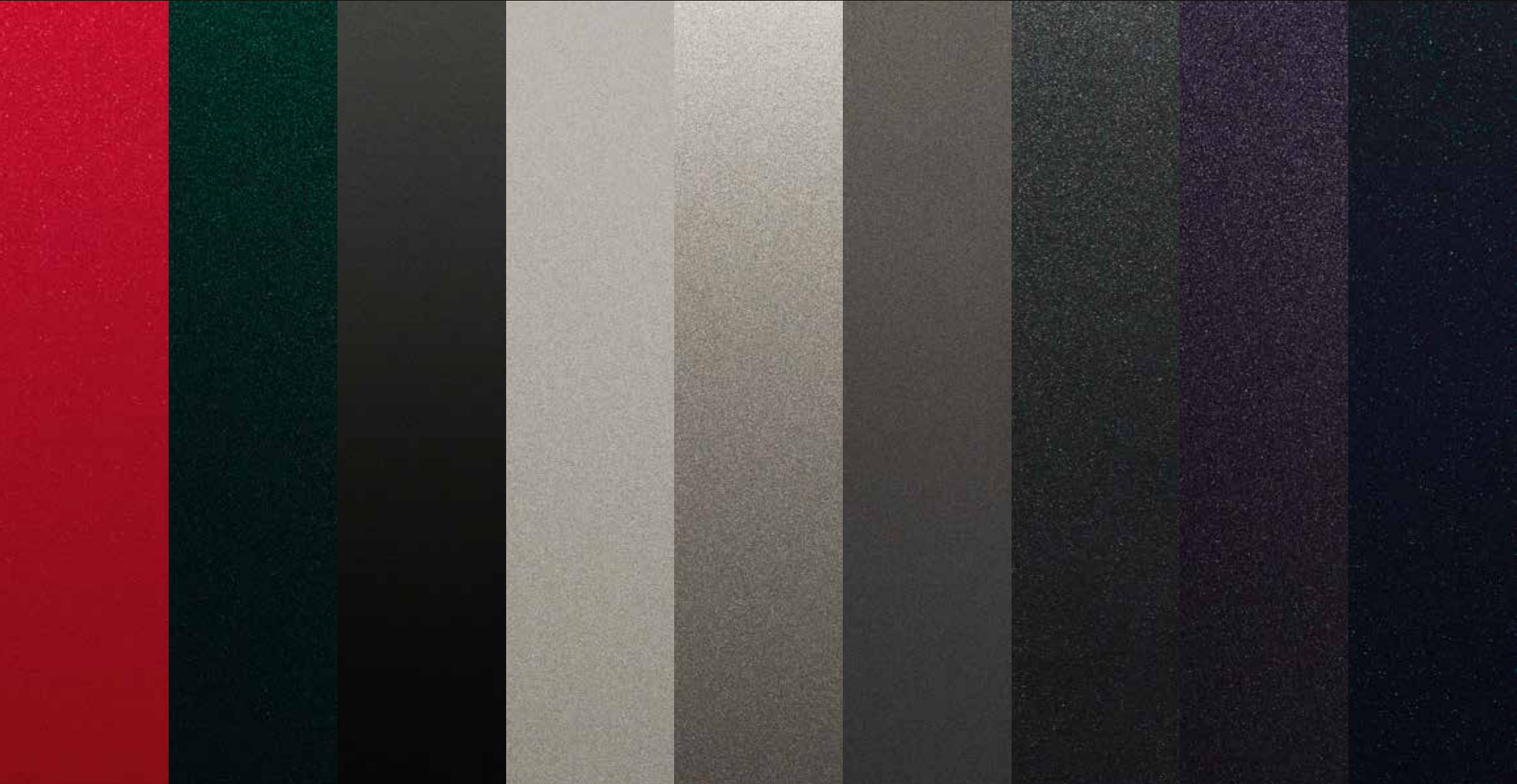

4 CHOOSE YOUR WHEELS

 Configure your vehicle at jaguar.com



	18" MANRA	18" MERU	19" ALEUTIAN	19" TOBA	19" SUNDA
ALLOY WHEEL FINISH	Sparkle Silver	Sparkle Silver	Sparkle Silver	Sparkle Silver	Sparkle Silver
ALLOY WHEEL / SIZE	8.0J x 18" / 9.0J x 18"	8.0J x 18" / 9.0J x 18"	9.0J x 19" / 10.0J x 19"	9.0J x 19" / 10.0J x 19"	9.0J x 19" / 10.0J x 19"
TYRE SIZE	245/50ZR18 / 275/45ZR18	245/50ZR18 / 275/45ZR18	245/45ZR19 / 275/40ZR19	245/45ZR19 / 275/40ZR19	245/45ZR19 / 275/40ZR19
CODE	C51S	C45B	C45C	C45D	C52F



	19" TOBA POLISHED	20" KASUGA	20" KASUGA POLISHED	20" ORONA
ALLOY WHEEL FINISH	Polished	High Gloss Silver	Polished	Silver
ALLOY WHEEL / SIZE	9.0J x 19" / 10.0J x 19"	9.0J x 20" / 10.0J x 20"	9.0J x 20" / 10.0J x 20"	9.0J x 20" / 10.0J x 20"
TYRE SIZE	245/45ZR19 / 275/40ZR19	245/40ZR20 / 275/35ZR20	245/40ZR20 / 275/35ZR20	245/40ZR20 / 275/35ZR20
CODE	C45E	C45G	C45H	C45J

Wheel availability is market dependent. Please consult your local Jaguar retailer for details.



20" ORONA POLISHED

20" MATAIVA

20" MAROA

20" VENOM

20" VENOM GLOSS BLACK

ALLOY WHEEL FINISH	Polished	Light Silver	Satin Grey and Diamond Turned	Sparkle Silver	Gloss Black
ALLOY WHEEL / SIZE	9.0J x 20" / 10.0J x 20"	9.0J x 20" / 10.0J x 20"	9.0J x 20" / 10.0J x 20"	9.0J x 20" / 10.0J x 20"	9.0J x 20" / 10.0J x 20"
TYRE SIZE	245/40ZR20 / 275/35ZR20	245/40ZR20 / 275/35ZR20	245/40ZR20 / 275/35ZR20	245/40ZR20 / 275/35ZR20	245/40ZR20 / 275/35ZR20
CODE	C45K	C45L	C46B	C46A	C52J



20" FARALLON TECHNICAL GREY

20" FARALLON SPARKLE SILVER

20" FARALLON GLOSS BLACK

ALLOY WHEEL FINISH	Technical Grey	Sparkle Silver	Gloss Black
ALLOY WHEEL / SIZE	9.0J x 20" / 10.0J x 20"	9.0J x 20" / 10.0J x 20"	9.0J x 20" / 10.0J x 20"
TYRE SIZE	265/35R20 / 295/30R20	265/35R20 / 295/30R20	265/35R20 / 295/30R20
CODE	C51Y	C51Z	C52H

5 CHOOSE YOUR INTERIOR

 Configure your vehicle at jaguar.com

LUXURY							
	SEAT BOND GRAIN LEATHER WITH STITCH	VENEER	MORZINE HEADLINING	UPPER FACIA BOND GRAIN LEATHER	LOWER FACIA	CARPET	INTERIOR TRIM AND OPTION CODES
Standard							
	Cashew/Cashew	Satin Rosewood	Ivory	Truffle	Cashew	Truffle	BAON
	Jet/Jet	Satin Rosewood	Ivory	Jet	Jet	Jet	BAOM
PREMIUM LUXURY							
	SEAT SOFT GRAIN PERFORATED LEATHER WITH STITCH/PIPING	VENEER	MORZINE HEADLINING	UPPER FACIA SOFT FEEL	LOWER FACIA	CARPET	INTERIOR TRIM AND OPTION CODES
Standard							
	Ivory/Oyster/Oyster	Gloss Rich Oak	Ivory	Oyster	Ivory	Oyster	BAOR
	Cashew/Truffle/Truffle	Gloss Rich Oak	Ivory	Truffle	Cashew	Truffle	BAOQ
	London Tan/Jet/Jet	Gloss Rich Oak	Ivory	Jet	Jet	Jet	BAOS
	Jet/Ivory/Ivory	Gloss Rich Oak	Ivory	Jet	Jet	Jet	BAOP
PORTFOLIO							
	SEAT SOFT GRAIN QUILTED AND PERFORATED LEATHER WITH STITCH	VENEER	PREMIUM SUEDECLOTH HEADLINING	UPPER FACIA SOFT GRAIN LEATHER	LOWER FACIA	CARPET	INTERIOR TRIM AND OPTION CODES
Standard							
	Navy/Ivory	Gloss Figured Ebony	Ivory	Navy	Navy	Navy	BAOY
	Jet/Ivory	Gloss Figured Ebony	Ivory or Jet	Jet	Jet	Jet	BAOT
	Cirrus/Mineral	Gloss Figured Ebony	Ivory	Mineral	Cirrus	Mineral	BAOX
	London Tan/Jet	Gloss Figured Ebony	Ivory or Jet	Jet	London Tan	Jet	BAOZ
	Cashew/Truffle	Gloss Figured Ebony	Ivory	Truffle	Cashew	Truffle	BAOU
	Ivory/Oyster	Gloss Figured Ebony	Ivory	Oyster	Ivory	Oyster	BAOW
	Ivory/Jet	Gloss Figured Ebony	Ivory or Jet	Jet	Ivory	Jet	BAOV

Standard and optional features may differ depending on market availability. Please consult your local Jaguar retailer for details.

AUTOBIOGRAPHY							
	SEAT SEMI-ANILINE QUILTED AND PERFORATED LEATHER WITH STITCH	VENEER	SOFT GRAIN LEATHER HEADLINING	UPPER FACIA SOFT GRAIN LEATHER	LOWER FACIA	CARPET	INTERIOR TRIM AND OPTION CODES
Standard							
	Ivory/Mineral	Gloss Rich Oak with Linear Laser Inlay	Ivory	Mineral	Ivory	Mineral	BAPE
	Ivory/Jet	Gloss Rich Oak with Linear Laser Inlay	Ivory or Jet	Jet	Ivory	Jet	BAPC
	Cirrus/Navy	Gloss Rich Oak with Linear Laser Inlay	Ivory	Navy	Cirrus	Navy	BAPF
	Cashew/Truffle	Gloss Rich Oak with Linear Laser Inlay	Ivory	Truffle	Cashew	Truffle	BAPB
	London Tan/Jet	Gloss Rich Oak with Linear Laser Inlay	Ivory or Jet	Jet	London Tan	Jet	BAPG
	Bordeaux/Bordeaux	Gloss Rich Oak with Linear Laser Inlay	Ivory or Jet	Jet	Bordeaux	Jet	BAPD
	Jet/Ivory	Gloss Rich Oak with Linear Laser Inlay	Ivory or Jet	Jet	Jet	Jet	BAPA
R-SPORT							
	SEAT SOFT GRAIN PERFORATED LEATHER WITH STITCH	VENEER	PREMIUM SUEDECLOTH HEADLINING	UPPER FACIA SOFT GRAIN LEATHER	LOWER FACIA	CARPET	INTERIOR TRIM AND OPTION CODES
Standard							
	Jet/Red	Piano Black	Ivory or Jet	Jet	Jet	Jet	BAPK
	Ivory/Jet	Piano Black	Ivory or Jet	Jet	Ivory	Jet	BAPL
XJR							
	SEAT SOFT GRAIN PERFORATED LEATHER WITH STITCH	VENEER	SOFT GRAIN LEATHER HEADLINING	UPPER FACIA SOFT GRAIN LEATHER	LOWER FACIA	CARPET	INTERIOR TRIM AND OPTION CODES
Standard							
	Jet/Red duo-tone/Red	Piano Black	Jet	Jet	Jet	Jet	BAMT
	Jet/Red	Piano Black	Jet	Jet	Jet	Jet	BAMQ
	Jet/London Tan duo-tone/London Tan	Piano Black	Jet	Jet	Jet	Jet	BAMU
	Jet/London Tan	Piano Black	Jet	Jet	Jet	Jet	BAMR
	Jet/Ivory duo-tone/Ivory	Piano Black	Jet	Jet	Jet	Jet	BAMS

5 CHOOSE YOUR INTERIOR

Configure your vehicle at jaguar.com









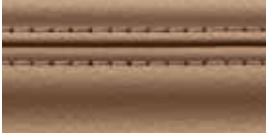

Interior Shown: Cashew Bond grain leather seats with Truffle upper facia, Ivory morzine headlining, Satin Rosewood veneer and Truffle carpet.



LUXURY

INTERIOR COLOUR COMBINATIONS

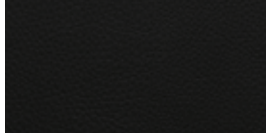
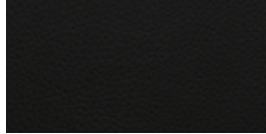
STANDARD - BOND GRAIN LEATHER

①	②	③	④	⑤	⑥
SEAT WITH TONAL STITCH	VENEER	MORZINE HEADLINING	UPPER FACIA	LOWER FACIA	CARPET
					
Cashew with Cashew stitch	Satin Rosewood	Ivory	Truffle	Cashew	Truffle
					
Jet with Jet stitch	Satin Rosewood	Ivory	Jet	Jet	Jet

VENEER OPTIONS

Carbon Fibre, Gloss Figured Ebony, Gloss Figured Ebony with Ribbon Laser Inlay, Gloss Burr Walnut, Gloss Rich Oak, Gloss Walnut Curl, Piano Black, Gloss Rich Oak with Linear Laser Inlay, Satin Elm, Satin Mid Zebrano or Shadow Walnut

5 CHOOSE YOUR INTERIOR

⚙️ Configure your vehicle at jaguar.com

























Interior shown: Ivory soft grain leather seats with Oyster upper facia, Ivory morzine headlining, Gloss Rich Oak veneer and Oyster carpet.



PREMIUM LUXURY

INTERIOR COLOUR COMBINATIONS

STANDARD - SOFT GRAIN LEATHER SEAT

1	2	3	4	5	6
SEAT WITH CONTRAST STITCH AND PIPING	VENEER	MORZINE HEADLINING	UPPER FACIA	LOWER FACIA	CARPET
 Ivory with Oyster stitch	 Gloss Rich Oak	 Ivory	 Oyster	 Ivory	 Oyster
 Cashew with Truffle stitch	 Gloss Rich Oak	 Ivory	 Truffle	 Cashew	 Truffle
 London Tan with Jet stitch	 Gloss Rich Oak	 Ivory	 Jet	 Jet	 Jet
 Jet with Ivory stitch	 Gloss Rich Oak	 Ivory	 Jet	 Jet	 Jet

VENEER OPTIONS

Carbon Fibre, Gloss Figured Ebony, Gloss Figured Ebony with Ribbon Laser Inlay, Gloss Burr Walnut, Satin Rosewood, Gloss Walnut Curl, Piano Black, Gloss Rich Oak with Linear Laser Inlay, Satin Elm, Satin Mid Zebrano or Shadow Walnut

5 CHOOSE YOUR INTERIOR

Configure your vehicle at jaguar.com

Interior Shown: Navy soft grain perforated quilted leather seats with Ivory contrast stitch, Navy upper fascia, Ivory Suedecloth headlining, Gloss Figured Ebony veneer and Navy carpet.













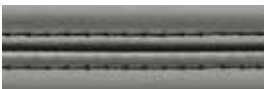



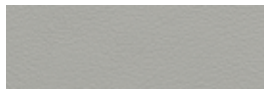

























Image shown includes Rear Seat Entertainment.



PORTFOLIO

INTERIOR COLOUR COMBINATIONS

STANDARD - SOFT GRAIN LEATHER SEAT

1	2	3	4	5	6
SEAT WITH CONTRAST STITCH	VENEER	SUEDECLOTH HEADLINING	UPPER FACIA	LOWER FACIA	CARPET
 Navy with Ivory stitch	 Gloss Figured Ebony	 Ivory	 Navy	 Navy	 Navy
 Jet with Ivory stitch	 Gloss Figured Ebony	 Ivory or Jet	 Jet	 Jet	 Jet
 Cirrus with Mineral stitch	 Gloss Figured Ebony	 Ivory	 Mineral	 Cirrus	 Mineral
 London Tan with Jet stitch	 Gloss Figured Ebony	 Ivory or Jet	 Jet	 London Tan	 Jet
 Cashew with Truffle stitch	 Gloss Figured Ebony	 Ivory	 Truffle	 Cashew	 Truffle
 Ivory with Oyster stitch	 Gloss Figured Ebony	 Ivory	 Oyster	 Ivory	 Oyster
 Ivory with Jet stitch	 Gloss Figured Ebony	 Ivory or Jet	 Jet	 Ivory	 Jet

VENEER OPTIONS

Carbon Fibre, Gloss Figured Ebony with Ribbon Laser Inlay, Gloss Burr Walnut, Gloss Rich Oak, Gloss Walnut Curl, Piano Black, Gloss Rich Oak with Linear Laser Inlay, Satin Elm, Satin Mid Zebrano, Satin Rosewood or Shadow Walnut

5 CHOOSE YOUR INTERIOR

⚙️ Configure your vehicle at jaguar.com

Interior shown: Ivory semi-aniline perforated leather seats with Mineral contrast stitch, Mineral upper fascia, Ivory leather headlining and Gloss Rich Oak with Linear Laser Inlay veneer and Mineral carpet.



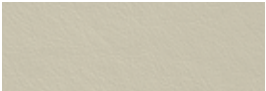





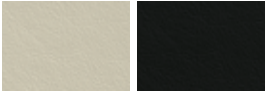





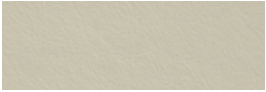

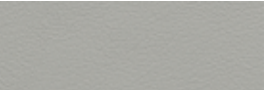



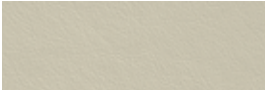





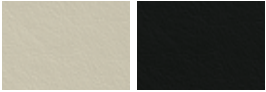





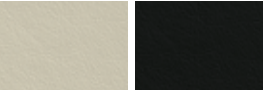





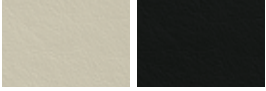



Image shown includes Rear Seat Entertainment.



AUTOBIOGRAPHY

INTERIOR COLOUR COMBINATIONS

STANDARD - SEMI-ANILINE LEATHER SEAT

1	2	3	4	5	6
SEAT WITH CONTRAST STITCH	VENEER	LEATHER HEADLINING	UPPER FACIA	LOWER FACIA	CARPET
 Ivory with Mineral stitch	 Gloss Rich Oak with Linear Laser Inlay	 Ivory	 Mineral	 Ivory	 Mineral
 Ivory with Jet stitch	 Gloss Rich Oak with Linear Laser Inlay	 Ivory or Jet	 Jet	 Ivory	 Jet
 Cirrus with Navy stitch	 Gloss Rich Oak with Linear Laser Inlay	 Ivory	 Navy	 Cirrus	 Navy
 Cashew with Truffle stitch	 Gloss Rich Oak with Linear Laser Inlay	 Ivory	 Truffle	 Cashew	 Truffle
 London Tan with Jet stitch	 Gloss Rich Oak with Linear Laser Inlay	 Ivory or Jet	 Jet	 London Tan	 Jet
 Bordeaux with Bordeaux stitch	 Gloss Rich Oak with Linear Laser Inlay	 Ivory or Jet	 Jet	 Bordeaux	 Jet
 Jet with Ivory stitch	 Gloss Rich Oak with Linear Laser Inlay	 Ivory or Jet	 Jet	 Jet	 Jet

VENEER OPTIONS

Carbon Fibre, Gloss Figured Ebony, Gloss Figured Ebony with Ribbon Laser Inlay, Gloss Burr Walnut, Gloss Rich Oak, Gloss Walnut Curl, Piano Black, Satin Elm, Satin Mid Zebrano, Satin Rosewood or Shadow Walnut

5 CHOOSE YOUR INTERIOR

⚙️ Configure your vehicle at jaguar.com

Interior shown: Jet soft grain leather sports seats with Red contrast stitch, Jet upper facia, Ivory suedecloth headlining, Piano Black veneer and Jet carpet.



R-SPORT

INTERIOR COLOUR COMBINATIONS

STANDARD - SOFT GRAIN LEATHER SEAT

①

LEATHER SEAT WITH
CONTRAST STITCH



Jet with Red stitch

②

VENEER



Piano Black

③

SUEDECLOTH HEADLINING



Ivory or Jet

④

UPPER FACIA



Jet

⑤

LOWER FACIA



Jet

⑥

CARPET



Jet

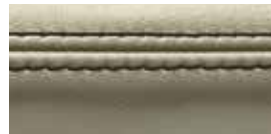

Ivory with Jet stitch



Piano Black



Ivory or Jet



Jet



Ivory



Jet

VENEER OPTION

Carbon Fibre

5 CHOOSE YOUR INTERIOR

⚙️ Configure your vehicle at jaguar.com

















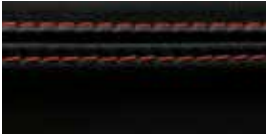













Interior shown: Jet/Red soft grain duotone leather seats with Red contrast stitch, Jet upper fascia, Jet Suedecloth headlining, Piano Black veneer and Jet carpet.

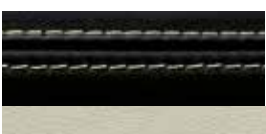

XJR

INTERIOR COLOUR COMBINATIONS

STANDARD - SOFT GRAIN LEATHER SEAT

1	2	3	4	5	6
LEATHER SEAT WITH CONTRAST STITCH	VENEER	SUEDECLOTH HEADLINING	UPPER FACIA	LOWER FACIA	CARPET
 <p>Jet/Red duotone with Red stitch</p>	 <p>Piano Black</p>	 <p>Jet</p>	 <p>Jet</p>	 <p>Jet</p>	 <p>Jet</p>
 <p>Jet with Red stitch</p>	 <p>Piano Black</p>	 <p>Jet</p>	 <p>Jet</p>	 <p>Jet</p>	 <p>Jet</p>
 <p>Jet/London Tan duotone with London Tan stitch</p>	 <p>Piano Black</p>	 <p>Jet</p>	 <p>Jet</p>	 <p>Jet</p>	 <p>Jet</p>
 <p>Jet with London Tan stitch</p>	 <p>Piano Black</p>	 <p>Jet</p>	 <p>Jet</p>	 <p>Jet</p>	 <p>Jet</p>
 <p>Jet/Ivory duotone with Ivory stitch</p>	 <p>Piano Black</p>	 <p>Jet</p>	 <p>Jet</p>	 <p>Jet</p>	 <p>Jet</p>

VENEER OPTION

Carbon Fibre

5 CHOOSE YOUR INTERIOR

 Configure your vehicle at jaguar.com

Piano Black

Carbon Fibre

Gloss Rich Oak

Satin Rosewood

Gloss Figured Ebony

Gloss Rich Oak
with Linear Laser Inlay



Gloss Figured Ebony
with Ribbon Laser Inlay

Gloss Walnut Curl

Gloss Burr Walnut

Gloss Shadow Walnut

Satin Elm

Satin Mid Zebrano



6 CHOOSE YOUR JAGUAR ACCESSORIES

To find out more about the full range of retailer fit Jaguar Accessories, please refer to your retailer or go to accessories.jaguar.com



Polished Tailpipe Finishers* C2D25247

Polished stainless steel exhaust finishers add further style and refinement to the XJ.

Availability is market dependent. Please consult your local Jaguar retailer for details.

*Not applicable for Autobiography and XJR models. **Not compatible with rear seat entertainment.



Chrome Mirror Cover
C2D5489 - Left
C2D5488 - Right

Chrome mirror covers accentuate the stylish design of the exterior mirrors. Left and right side options available.



Headrest Mounted Coat Hanger**
C2Z23416

The Jaguar coat hanger is a headrest mounted solution featuring Jaguar branding and a chromed 'spring fit' construction. Mounting simply and securely this coat hanger is easy to fit and remove and provides a convenient stowage point to keep clothing wrinkle free.



Aluminium Gearshift Paddles
T2R6547MMU

Replacement steering wheel gearshift paddles offered in a premium aluminium material providing a high quality finish to a key contact point in the vehicle. Manufactured from billet machined aluminium, the paddles are hand brushed for a premium finish and anodised to ensure they will not deteriorate with wear.



Illuminated Treadplate

Elegantly styled aluminium sill tread plates illuminate when the driver or passenger doors are opened. Highlighted by soft phosphor blue lighting. Please consult your authorised Jaguar retailer for ordering information.



iPad Holder**
C2Z22935

Jaguar branded iPad® holder mounts to front seat headrests providing a flexible solution for rear seat entertainment. Quick release design ensures iPad® can be fitted or removed quickly and easily.



Premium Loadspace Mat
C2D7450

Luxurious soft luggage mat in Jet Black with the Jaguar logo. Deep premium 2,050g/m² pile with nubuck edging and Dove contrast stitch.

TECHNICAL SPECIFICATIONS

 Configure your vehicle at jaguar.com

ENGINES		JAGUAR 2.0 LITRE 4 CYLINDER 240 TURBOCHARGED PETROL	JAGUAR 3.0 LITRE V6 300 TURBOCHARGED DIESEL	JAGUAR 3.0 LITRE V6 340 SUPERCHARGED PETROL		JAGUAR 5.0 LITRE V8 470 SUPERCHARGED PETROL	JAGUAR 5.0 LITRE V8 510 SUPERCHARGED PETROL	JAGUAR 5.0 LITRE V8 550 SUPERCHARGED PETROL
Drive		RWD	RWD	RWD	AWD	RWD	RWD	RWD
Capacity	cc	1999	2993	2995	2995	5000	5000	5000
Maximum power	EEC-PS (kW)	240 (177)	300 (221)	340 (250)	340 (250)	470 (346)	510 (375)	550 (405)
@rev/min		5,500	4,000	6,500	6,500	6,000-6,500	6,000-6,500	6,000-6,500
Maximum torque	EEC-Nm (lb.ft.)	340 (251)	700 (516)	450 (332)	450 (332)	575 (424)	625 (461)	680 (502)
@rev/min		2,000-4,000	2,000	3,500-5,000	3,500-5,000	2,000-5,500	2,500-5,500	3,500-4,000
Transmission		8-speed automatic	8-speed automatic	8-speed automatic	8-speed automatic	8-speed automatic	8-speed automatic	8-speed automatic
PERFORMANCE								
0-100 km/h	seconds	7.9	6.2	5.9	6.4	5.2	4.9	4.6
0-60 mph	seconds	7.5	5.9	5.7	6.1	4.9	4.7	4.4
Top speed	km/h (mph)	241 (150)	250 (155) limited	250 (155) limited	250 (155) limited	250 (155) limited	250 (155) limited	280 (174) limited
FUEL CONSUMPTION ¹ - STANDARD WHEELBASE								
Urban	l/100km (mpg)	11.4 (24.8)	7.0 (40.4)	12.5 (22.6)	13.6 (20.8)	16.2 (17.4)	—	16.2 (17.4)
Extra Urban	l/100km (mpg)	6.7 (42.2)	5.2 (54.3)	7.1 (39.8)	7.6 (37.2)	8.2 (34.5)	—	8.2 (34.5)
Combined	l/100km (mpg)	8.4 (33.6)	5.7 (49.6)	9.1 (31.0)	9.8 (28.8)	11.1 (25.5)	—	11.1 (25.5)
Carbon dioxide emissions	g/km	199	149	211	234	264	—	264
Tank capacity (usable)	ltr approx.	80	77	80	80	80	—	80
FUEL CONSUMPTION ¹ - LONG WHEELBASE								
Urban	l/100km (mpg)	11.4 (24.8)	7.0 (40.4)	12.5 (22.6)	13.6 (20.8)	16.2 (17.4)	16.2 (17.4)	16.2 (17.4)
Extra Urban	l/100km (mpg)	6.7 (42.2)	5.2 (54.3)	7.1 (39.8)	7.6 (37.2)	8.2 (34.5)	8.2 (34.5)	8.2 (34.5)
Combined	l/100km (mpg)	8.4 (33.6)	5.7 (49.6)	9.1 (31.0)	9.8 (28.8)	11.1 (25.5)	11.1 (25.5)	11.1 (25.5)
Carbon dioxide emissions	g/km	199	149	211	234	264	264	264
Tank capacity	ltr approx.	80	77	80	80	80	80	80

Engine availability is market dependent.
Please consult your local Jaguar retailer for details.

¹Official EU test figures. For comparison purposes only. Real world figures may differ.

²Weights reflect vehicles to standard specifications. Optional extras increase weight.

STANDARD WHEELBASE		JAGUAR 2.0 LITRE 4 CYLINDER 240 TURBOCHARGED PETROL	JAGUAR 3.0 LITRE V6 300 TURBOCHARGED DIESEL	JAGUAR 3.0 LITRE V6 340 SUPERCHARGED PETROL	JAGUAR 5.0 LITRE V8 470 SUPERCHARGED PETROL	JAGUAR 5.0 LITRE V8 510 SUPERCHARGED PETROL	JAGUAR 5.0 LITRE V8 550 SUPERCHARGED PETROL	
		RWD	RWD	RWD	AWD	RWD	RWD	RWD
Drive								
Overall length	mm	5,130	5,130	5,130	5,130	—	5,130	5,130
Overall width (inc./exc. mirrors)	mm	2,105/1,899	2,105/1,899	2,105/1,899	2,105/1,899	2,105/1,899	—	2,105/1,899
Overall height (inc. antenna)	mm	1,460	1,460	1,460	1,460	1,460	—	1,460
Wheelbase	mm	3,032	3,032	3,032	3,032	3,032	—	3,032
Front/Rear track	mm	1,626/1,604	1,626/1,604	1,626/1,604	1,626/1,604	1,626/1,604	—	1,626/1,604
Turning circle diameter (kerb to kerb)	m (ft.in)	11.9 (39.0)	11.9 (39.0)	11.9 (39.0)	12.4 (40.7)	11.9 (39.0)	—	11.9 (39.0)
Boot volume with tyre repair system	litres - VDA (cu.ft.)	478	478	478	478	478	—	478
Front/Rear legroom	mm	1,055/988	1,055/988	1,055/988	1,055/988	1,055/988	—	1,055/988
Headroom with sunroof (front)	mm	1,004	1,004	1,004	1,004	1,004	—	1,004
Headroom (rear)	mm	945	945	945	945	945	—	945
Front/Rear shoulder room	mm	1,464/1,437	1,464/1,437	1,464/1,437	1,464/1,437	1,464/1,437	—	1,464/1,437
Weight ²	kg (lbs)	1,735 (3,825)	1,835 (4,045)	1,765 (3,891)	1,865 (4,112)	1,875 (4,134)	—	1,875 (4,134)
Gross vehicle weight ²	kg (lbs)	2,280 (5,026)	2,400 (5,291)	2,350 (5,181)	2,430 (5,357)	2,400 (5,291)	—	2,400 (5,291)

LONG WHEELBASE		JAGUAR 2.0 LITRE 4 CYLINDER 240 TURBOCHARGED PETROL	JAGUAR 3.0 LITRE V6 300 TURBOCHARGED DIESEL	JAGUAR 3.0 LITRE V6 340 SUPERCHARGED PETROL	JAGUAR 5.0 LITRE V8 470 SUPERCHARGED PETROL	JAGUAR 5.0 LITRE V8 510 SUPERCHARGED PETROL	JAGUAR 5.0 LITRE V8 550 SUPERCHARGED PETROL
Overall length	mm	5,255	5,255	5,255	5,255	5,255	5,255
Overall width (inc./exc. mirrors)	mm	2,105/1,899	2,105/1,899	2,105/1,899	2,105/1,899	2,105/1,899	2,105/1,899
Overall height (inc. antenna)	mm	1,460	1,460	1,460	1,460	1,460	1,460
Wheelbase	mm	3,157	3,157	3,157	3,157	3,157	3,157
Front/Rear track	mm	1,626/1,604	1,626/1,604	1,626/1,604	1,626/1,604	1,626/1,604	1,626/1,604
Turning circle diameter (kerb to kerb)	m (ft.in)	12.3 (40.4)	12.3 (40.4)	12.3 (40.4)	12.9 (42.3)	12.3 (40.4)	12.3 (40.4)
Boot volume with tyre repair system	litres - VDA (cu.ft.)	478	478	478	478	478	478
Front/Rear legroom	mm	1,055/1,109	1,055/1,109	1,055/1,109	1,055/1,109	1,055/1,109	1,055/1,109
Rear legroom with Rear Seat Package (rear seat fully upright)	mm	1,109	1,109	1,109	1,109	1,109	1,109
Rear legroom with Rear Seat Package (rear seat fully reclined)	mm	1,021	1,021	1,021	1,021	1,021	1,021
Rear legroom with Premium Rear Seat Package (rear seat fully upright)	mm	1,087	1,087	1,087	1,087	1,087	1,087
Rear legroom with Premium Rear Seat Package (rear seat fully reclined)	mm	989	989	989	989	989	989
Headroom with sunroof (front)	mm	1,004	1,004	1,004	1,004	1,004	1,004
Headroom (rear)	mm	960	960	960	960	960	960
Front/Rear shoulder room	mm	1,464/1,437	1,464/1,437	1,464/1,437	1,464/1,437	1,464/1,437	1,464/1,437
Weight ²	kg (lbs)	1,755 (3,869)	1,860 (4,101)	1,775 (3,913)	1,875 (4,134)	1,885 (4,156)	1,885 (4,156)
Gross vehicle weight ²	kg (lbs)	2,320 (5,115)	2,450 (5,401)	2,400 (5,291)	2,450 (5,401)	2,450 (5,401)	2,450 (5,401)

DIMENSIONS

Overall Width (inc mirrors) 2,105mm

Overall Width (exc mirrors) 1,899mm

Boot Volume 478 Litres

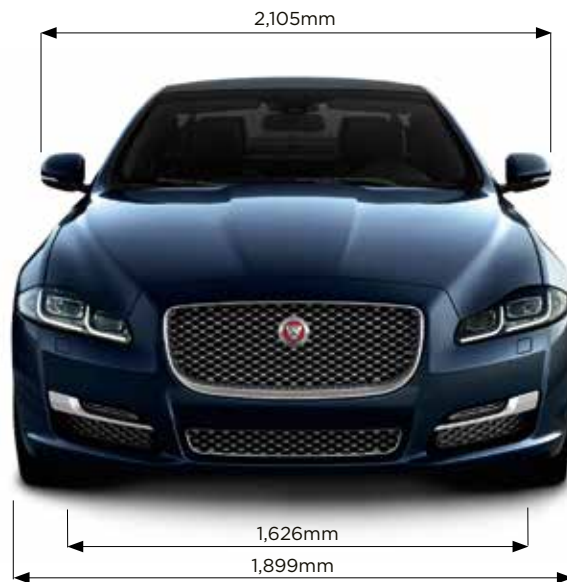

VEHICLE SHOWN: XJ PORTFOLIO STANDARD WHEELBASE (SWB) WITH OPTIONAL FEATURES FITTED (MARKET DEPENDENT)

Turning Circle (SWB)

Kerb-to-kerb RWD 11.90m

Kerb-to-kerb AWD 12.40m

Turning Circle (LWB)

Kerb-to-kerb RWD 12.30m

Kerb-to-kerb AWD 12.90m



Dimensions were measured with vehicle at unladen weight.
Boot volume measured by VDA standard test method using 200 x 100 x 50mm blocks.

JAGUAR EXPERIENCE

There's no better way to get to know Jaguar than by taking a drive. The Jaguar Experience offers a range of unique opportunities to really find out what it feels like to get the most out of a Jaguar. Our track experiences allow you to push yourself and cars from the incredible Jaguar range to the limit. Jaguar Experience also offers the opportunity to see a Jaguar brought to life during a tour of one of our UK manufacturing facilities.

Find out more by visiting jaguar.com/experience



BEHIND THE SCENES

Our factory tours give you the unique opportunity to experience the whole process of how our cars are brought to life - from the moulding of sheet metal to those intricate final touches. At our state-of-the-art production facilities, you'll get to see how skilled technicians and sophisticated machines work seamlessly together to perfect some of Jaguar's most breathtaking cars - from the powerful F-TYPE to the groundbreaking F-PACE performance SUV.

Find out more at jaguar.com/experience-jaguar/behind-the-scenes



DRIVING EXPERIENCES

The opportunity to drive the latest Jaguar cars at their limits, or relive iconic Jaguar history, is rare. Jaguar Driving Experiences offer unique driving adventures you will never forget. Imagine yourself behind the wheel of our highest performing Jaguar models, on a private track, with a Jaguar Experience Instructor at your side. This is the Jaguar Performance Driving Academy.

Find out more at [jaguar.com/experience-jaguar/driving-experiences](https://www.jaguar.com/experience-jaguar/driving-experiences)



ICONIC EXPERIENCES

Take your driving to the next level with our international adventures facing extreme road, and off-road, conditions. Our Iconic Experiences offer journeys and challenges that will test and develop your performance driving skills. Every year, Jaguar customers and enthusiasts join us for our luxury Ice Driving Experience. The exclusive ski resort in Gstaad, Switzerland, is the perfect location to enjoy the thrill of performance driving on ice. Our Ice Driving Experience is a two-day getaway held each winter. You can get a flavour of the event below. Then, if you'd like to be part of it in the next experience, we can keep you posted.

Find out more at [jaguar.com/experience-jaguar/iconic-experiences](https://www.jaguar.com/experience-jaguar/iconic-experiences)

THE WORLD OF JAGUAR

Choose an XJ and you're joining the exciting World of Jaguar. It makes owning and driving carefree and easy, as well as providing a range of exclusive services and lifestyle products.



SERVICING

With each new generation of Jaguar, we strive to improve servicing and repair requirements through the use of new technologies, synthetic lubricants and enhanced serviceability. Our vehicles are also designed for longer service intervals and ease of maintenance, which further reduces running costs.

GENUINE PARTS

Jaguar Genuine Parts are designed, tested and manufactured to our uncompromising standards for quality, fit and durability. Each part is engineered specifically for your XJ to contribute to optimum performance and to help maximise its lifespan.



JAGUAR FINANCIAL SERVICES

Effortless performance and style come as standard with every Jaguar. Jaguar Financial Services makes buying one just as simple and rewarding. New or used, for personal or business use, we have an option that puts you in complete control. Please speak to your local Jaguar retailer to find out more.



JAGUAR ASSISTANCE

Jaguar Assistance provides assistance in motoring emergencies, from immobilisation due to breakdown or accident to minor problems such as punctures. You can rely on our roadside assistance, whatever the situation, wherever you happen to be.

LOW INSURANCE

XJ's key components are easily accessible for time-efficient service and repair costs. With a focus on lower repair costs, XJ delivers competitive insurance group ratings*. To find out more about the compelling business case for XJ, please contact your local Jaguar retailer.



FLEET & BUSINESS

Jaguar is dedicated to being the premium manufacturer of choice for fleets and businesses by providing a highly attractive car range and exemplary customer service. Jaguars are dynamic and distinctive cars that help companies express the unique character and personality of their business. We are committed to providing totally customer-focused aftersales services, which keeps every Jaguar car on the move and in top condition, ensuring that they perform to the highest standard and in the most cost-efficient way for businesses. Visit jaguar.com/fleet-and-business for more information.



JAGUAR MAGAZINE

Jaguar Magazine is the official magazine of Jaguar Cars. It features the Jaguar XJ, XF, XE, F-TYPE and F-PACE, and the worlds of luxury, style, design and travel.

JAGUAR COLLECTION

The latest range from the Jaguar Collection has been crafted with the same design execution and attention to detail that goes into all of our cars. This is evident in our clothing range, premium leather items and luxury travel goods. To celebrate Jaguar's heritage we also have a collection that honours past achievements and features race inspired gift items and apparel. To find out more, visit the online shop at jaguar.com/shop

*Manufacturer's estimate.

GLOSSARY

#

3D MAPPING

Three dimensional mapping is a selectable view mode in the navigation system. It provides an aerial view of the landscape with three dimensional buildings to greatly enhance user orientation.

7.1 SURROUND SOUND

7.1 Surround Sound is the common name for an eight-channel surround sound system.

A

ABS SYSTEM

The Anti-lock Braking System prevents wheel lock up under heavy braking to maintain vehicle control.

AIR SUSPENSION

Rear air suspension replaces conventional steel springs with pneumatic air springs to provide maximum ride comfort and control by automatically adjusting spring rates to suit the situation.

AUTO-DIMMING INTERIOR REAR VIEW MIRROR

Auto-dimming mirrors automatically reduce reflected glare from following cars' headlights.

D

DIGITAL SOUND PROCESSOR (DSP)

Meridian's Digital Signal Processing (DSP) technology analyses a range of variables that may impact audio quality, then processes them using sophisticated algorithms and adapts the system's output accordingly. This enables a level of powerful, authentic performance impossible with a conventional sound system.

F

FOUR ZONE CLIMATE CONTROL

Adds independent automatic temperature control for left and right rear passengers in addition to the front dual zone.

H

HEAT-REFLECTIVE GLASS

This glass reflects infrared light waves and so reduces heat build-up inside the car caused by direct sunlight.

I

INSTRUMENT PANEL DISPLAY

The Instrument Panel Display is a 12.3 inch High Definition TFT (Thin Film Transistor) screen that replaces the traditional instrument cluster. It displays a wide range of key driving information. Four graphical themes and a 3D map view are available.

J

JAGUAR SMART KEY SYSTEM - KEYLESS START

When the Smart Key is present in the car, simply push the Start button to start the engine.

JAGUARDRIVE CONTROL

Interacts with the Dynamic Stability Control system, engine and transmission management systems to alter the characteristics of the engine mapping, gear shifts and brakes. It offers different modes designed to optimise the vehicle's response to particular driving conditions and styles.

JAGUARDRIVE SELECTOR

The JaguarDrive Selector rises from the centre console on start up. It is a rotary shifter used with automatic transmissions that allows you to quickly shift between drive modes.

L

LIMOUSINE RIDE SUSPENSION

For Long Wheelbase versions of XJ, the rear air suspension has been specially recalibrated to optimise comfort, providing limousine like ride quality.

P

PSYCHOACOUSTICS

Psychoacoustics is the study of the psychological and physiological responses associated with listening to sound.

S

SOLAR ATTENUATING GLASS

This glass filters sunlight to reduce glare and prevent harmful UV rays from entering the cabin.

T

TRIFIELD™

Meridian's exclusive Trifield technology, delivers a consistent, concert-like experience, optimised for all seating positions.

W

WINTER MODE

By selecting Winter Mode, the system automatically dampens acceleration and applies more gradual torque for improved control in slippery conditions.



IMPORTANT NOTICE

Jaguar Land Rover Limited is constantly seeking ways to improve the specification, design and production of its vehicles and alterations take place continually. While every effort is made to produce up-to-date literature, this brochure should not be regarded as an infallible guide to current specifications, nor does it constitute an offer for the sale of any particular vehicle. Vehicles shown in this brochure are from the Jaguar Global range. Specifications, options and availability will vary between markets and should be verified with your local Jaguar Retailer. Distributors and Retailers are not agents of Jaguar Land Rover Limited by any express or implied undertaking or representation.

Comparisons are based on manufacturer's own data and testing prior to publication.

COLOURS

Print and online colours are representative only.

ENVIRONMENTAL INNOVATION AT JAGUAR

XJ, XE, XF, F-PACE and F-TYPE's innovative use of lightweight aluminium, which incorporates up to 50% closed-loop recycled material from the manufacturing process of the body structures, provides considerable performance benefits.

This includes improved fuel consumption and less CO₂ emissions during the use phase of the Life Cycle due to lighter structures. Our on-going target is to ensure scrap aluminium reclaimed from our stamping process is to be segregated and recycled through a closed loop system and incorporated back into the same grade quality aluminium sheet, therefore reducing CO₂ emissions, versus the use of virgin aluminium sheets, during the production phase of the Life Cycle. Jaguar is committed to reducing dependency on fossil fuels, using fewer natural resources and creating less waste as part of our approach to responsible and sustainable business development, called Environmental Innovation. The company plan includes ongoing reduction in CO₂ emissions & the use of natural resources and at the end of 2014 we have achieved a 28% reduction in operating CO₂ emissions, 25% in the Company's European fleet average tailpipe emissions, 75% in waste to landfill, logistics efficiencies (18%) and water consumption (10%), all based on per vehicle built since 2007. In addition the manufacturing assembly CO₂ emissions of each Jaguar built in the UK since 2009, is 100% offset as part of our 2020 strategy for carbon neutral manufacturing assembly and since 2013 carbon-for-development projects form a key part of the company's Global Corporate Social Responsibility (CSR) programme.

For each tonne of CO₂ emitted in the assembly process, the company invests in emissions reductions projects that reduce an equivalent tonne of CO₂ elsewhere and provide social and humanitarian benefits at the same time. Since 2013 the programme has offset 800,000 tonnes of CO₂ and improved the lives of over 2 million people from our award winning Lifestraw carbon-for-water emissions reduction programme. Taking into account the company's global sales growth and increased investment in more efficient operating facilities, we are proud to have delivered and in some cases exceeded our Environmental Innovation targets as planned between 2012-2015. But it doesn't stop there. Our manufacturing facilities have been certified to ISO14001 since 1998 and in 2013 the Company was recognised as the UK's Responsible Business of the Year by leading CR index, Business in the Community. In 2014 we built on this success through the Queens award for Enterprise in Sustainable Development for 2014. Looking forward, we have developed our 2020 vision for sustainable business growth that focuses on continued improvements in operating & tailpipe CO₂ emissions, carbon neutral manufacturing and zero waste. The company will also improve the lives of 12 million people by 2020 as part of the global Corporate Social Responsibility programme.

Meridian is the registered trademark of Meridian Audio Ltd.

AdBlue® is the registered trademark of the Verband der Automobilindustrie e. V. (VDA)

The Bluetooth® word mark and logos are owned by the Bluetooth SIG, Inc. and any use of such marks by Jaguar Land Rover Limited is under licence.

iPod, iPod touch and iPad are trademarks of Apple Inc, registered in the US and other countries.

The Navigation system must always be used in conditions that will not affect the driver's ability to drive safely or affect the safety of other road users.

Celeron, Centrino, Intel, the Intel logo, Intel Atom, Intel Core, Intel Inside, the Intel Inside logo, Intel vPro, Intel Xeon Phi, Itanium, Pentium, and Xeon are trademarks of Intel Corporation in the U.S and/or other countries.

VEHICLE SHOWN FRONT COVER: XJ R-SPORT LONG WHEELBASE IN ULTIMATE BLACK WITH OPTIONAL FEATURES FITTED (MARKET DEPENDENT)
VEHICLE SHOWN BACK COVER: XJ PORTFOLIO LONG WHEELBASE IN QUARTZITE WITH OPTIONAL FEATURES FITTED (MARKET DEPENDENT)

Jaguar Land Rover Limited
Registered Office: Abbey Road, Whitley,
Coventry, CV3 4LF, United Kingdom
Registered in England Number: 1672070
jaguar.com



May 2016/17MY
JLM/21/02/34/0516

